

The background features a stylized map of northeastern Illinois expressways. Major routes shown include I-290 Eisenhower Expy., I-90 Kennedy, and I-55. Various interchanges and local streets are labeled with their corresponding Annual Average Daily Traffic (AADT) volumes. For example, I-290 has volumes ranging from 8,500 to 102,200, while I-90 Kennedy has volumes from 3,600 to 94,000. Local streets like Morgan St., Wilson Ave., and 25th. Ave. are also marked with traffic counts. The map is overlaid with a grid and various data points, all in shades of blue and white.

# 2016 Expressway Atlas Annual Average Daily Traffic on Northeastern Illinois Expressways



# Table of Contents

<b>Introduction .....</b>	<b>3</b>
<b>System Summaries.....</b>	<b>5</b>
<b>Flow Graphics</b>	
I-55 Stevenson Expressway.....	12
I-57 Expressway .....	17
I-80 Expressway .....	19
I-80/94 Kingery Expressway .....	20
I-90/94 Dan Ryan Expressway.....	21
I-90/94/190 Kennedy Expressway .....	25
I-94 Bishop Ford Freeway .....	31
I-94 Edens Expressway.....	33
I-290 Eisenhower Expressway.....	35
I-290 Extension Expressway .....	40
Illinois Route 53.....	43
North U.S. 41 Lake Shore Drive.....	44
South U.S. 41 Lake Shore Drive .....	46





Chicago Metropolitan  
Agency for Planning

# 2016 Expressway Atlas

## Part 1: Introduction, methods, system data





# Introduction

The 2016 Expressway Atlas provides a desktop reference of annual average daily traffic (AADT) volumes and other traffic system statistics, as well as graphics, for northeastern Illinois. The data included in the Expressway Atlas is useful as baseline data for traffic planning. The data is also useful as an input to traffic simulation models and many other expressway-system studies such as safety analysis and pavement design.

Overall, on IDOT facilities equipped with surveillance in both 2015 and 2016, average daily vehicle miles traveled (VMT) on the Chicago region's expressway system increased 3.12% from 27,733,833 to 28,600,103. This continues an upward trend of VMT growth on the region's expressway system since 2014. During the late 2000s and early 2010s average daily VMT on IDOT's expressway system in the Chicago region experience little or no growth, but this trend reversed in 2014. The major drivers for the recent uptick in VMT is the decrease in gasoline prices and a strong economy. The increase in the average daily VMT did not include IL-390 since the facility converted to an Illinois tollway facility in 2016.

## Methods

The 2016 Expressway Atlas provides a graphic depiction of CMAP-estimated 2016 traffic volumes on IDOT expressways and ramps that are equipped with traffic counting devices in northeastern Illinois. The analysis period extends from January 2016 to November 2016.<sup>1</sup> The data and estimates are shared between IDOT and CMAP in a cooperative arrangement.

This Atlas is an update of the 2012 and 2014 Expressway Atlas, posted under Road Resources at <http://www.cmap.illinois.gov/mobility/roads>. The 2012 Atlas provides more extensive information on the expressway system than this atlas, including system data, daily and monthly factors, AADT tables, and hourly percent tables. So the 2012 Atlas remains a valid reference for regional traffic planners.

The primary source of IDOT traffic count data are inductive loop detectors, which are embedded in the pavement along the IDOT system, including entrance and exit ramps. The inductive loop detects the presence and passage of vehicles. This data is transmitted to a central control system. IDOT then applies an algorithm to calculate a count from the percent of time the inductive loop detects vehicles. The data used to create the 2016 average daily VMT estimates was from CMAP's regional transportation data archive.

The 2016 Expressway Atlas contains figures and graphics at the regional level and at the facility level, as well as detailed AADT flow graphics. CMAP staff used the American Association of

<sup>1</sup> The one-month offset from a calendar year is to facilitate the completion of AADT estimates in time for inclusion in IDOT's annual public release of the Illinois Highway Information System (IHIS).

State Highway and Transportation Officials (AASHTO) formula for calculating pre-balanced AADT for each mainline count station and ramp on the IDOT system.

The AASHTO method calculates an average day of week for each month, then an annual average value for each day of the week, and finally a single annual average daily value is computed for each ramp and mainline count station. This method helps to clean the data of counting errors caused by equipment failure or the effects of non-representative days such as blizzards or floods that produce severe outliers in the data.<sup>2</sup>

Many of the figures and graphics were produced through a process of traffic balancing. Traffic balancing is a process used to adjust ramp counts, when necessary, to match mainline station counts. In the event of missing count data for the entire year or if the AADT for a location was determined to have data quality issues, historical count information was used in the balancing process.

The regional figures and graphics provide area-wide traffic trends for the year 2014. Through the balancing process, an AADT estimate for all mainline count stations and ramps is calculated. With this data, along with milepost information, a VMT estimate is calculated for each facility; then a regional total is calculated. This information is displayed in the VMT table along with historical VMT data. The mainline AADT map provides a visual display of the distribution of traffic on IDOT expressways for an average day in 2014.

The flow graphics provide detailed AADT volumes for the entire IDOT expressway system equipped with counting devices. The AADT flow graphics provide link-by-link and ramp-by-ramp counts using highly detailed drawings representing portions of each expressway facility.

<sup>2</sup> Federal Highway Administration, *Traffic Monitoring Guide*, September, 2013. Pp 1-5 – 1-6. Posted at [http://www.fhwa.dot.gov/policyinformation/tmguidetmg\\_fhwa\\_pl\\_13\\_015.pdf](http://www.fhwa.dot.gov/policyinformation/tmguidetmg_fhwa_pl_13_015.pdf) (accessed April, 2015).



## IDOT Average Daily Expressway VMT from Roadway Detectors in the CMAP Region

Expressway	1984	1990	2000	2010	2015	2016
IL-53 Northbound	184,775	382,559	500,161	398,911	443,387	443,809
IL-53 Southbound	222,958	439,638	506,883	436,544	444,259	460,944
I-57 Northbound	449,404	600,477	766,188	859,724	830,271	898,489
I-57 Southbound	450,132	590,271	763,534	865,977	853,749	903,191
I-94 Edens Eastbound	775,174	979,936	1,107,772	988,640	1,002,577	1,029,766
I-94 Edens Westbound	842,212	1,010,654	1,153,287	1,061,950	1,054,459	1,080,698
IL-390 Elgin-O'Hare Eastbound*	-	-	197,453	184,398	175,910	-
IL-390 Elgin-O'Hare Westbound*	-	-	201,784	179,244	168,538	-
I-94 Bishop Ford Eastbound	531,841	606,038	874,268	930,082	925,466	932,219
I-94 Bishop Ford Westbound	504,978	643,850	849,725	887,430	890,105	902,241
I-290 Extension Eastbound	667,494	960,999	1,169,370	1,025,605	1,114,090	1,129,471
I-290 Extension Westbound	676,384	966,399	1,218,710	1,089,012	1,163,064	1,231,466
I-290 Eisenhower Eastbound	1,112,610	1,254,417	1,350,628	1,240,984	1,279,950	1,309,594
I-290 Eisenhower Westbound	1,108,271	1,245,097	1,355,959	1,208,316	1,276,466	1,282,440
I-90/94 Kennedy local Eastbound	1,323,081	1,650,155	1,493,186	1,521,475	1,546,999	1,564,343
I-90/94 Kennedy local Westbound	1,345,714	1,705,321	1,421,093	1,610,128	1,668,883	1,713,157
I-90/94 Eastbound Reversible lanes	99,120	143,016	131,131	144,043	174,385	164,077
I-90/94 Westbound Reversible lanes	141,007	170,700	172,443	149,834	183,635	160,898
I-80 Eastbound	204,615	279,835	-	679,775	830,315	987,713
I-80 Westbound	196,909	285,918	-	689,195	810,010	1,064,569
I-80 Kingery Eastbound	109,178	172,931	201,138	230,579	260,780	281,656
I-80 Kingery Westbound	107,820	169,032	199,597	222,171	285,651	293,028
US-41 North Lake Shore Drive Northbound	-	-	496,177	463,216	483,142	494,168
US-41 North Lake Shore Drive Southbound	-	-	511,622	471,789	485,286	486,183
US-41 South Lake Shore Drive Northbound	-	207,629	246,955	199,325	267,466	286,486
US-41 South Lake Shore Drive Southbound	-	221,149	259,697	233,781	266,615	261,728
I-90/94 Dan Ryan Local Eastbound	757,120	910,099	949,004	1,008,842	1,042,124	1,085,408
I-90/94 Dan Ryan Local Westbound	758,054	1,061,048	842,611	906,608	1,042,032	1,090,486
I-90/94 Dan Ryan Express Eastbound	368,771	400,051	436,106	385,476	418,844	420,236
I-90/94 Dan Ryan Express Westbound	391,945	444,118	484,870	378,996	434,985	408,265
I-55 Stevenson Northbound**	1,121,651	1,485,483	1,717,359	2,087,048	2,946,001	3,130,842
I-55 Stevenson Southbound**	1,122,638	1,444,341	1,758,656	2,118,377	2,964,389	3,102,532
<b>Total Regional Expressway VMT</b>	<b>15,573,856</b>	<b>20,431,161</b>	<b>23,337,367</b>	<b>24,857,475</b>	<b>27,733,833</b>	<b>28,600,103</b>

\* - IL-390 Elgin-O'Hare converted to an Illinois Tollway facility in 2016.

\*\* - Additional 30 centerline miles of surveillance added in 2014 on I-55. The additional surveillance on I-55 was in the southern part of the CMAP region, from IL-53 to IL-113/Coal City Rd.

# IDOT Average Daily Expressway Vehicle Miles Traveled (VMT) 1984, 1990, 2000, 2010, & 2015-2016

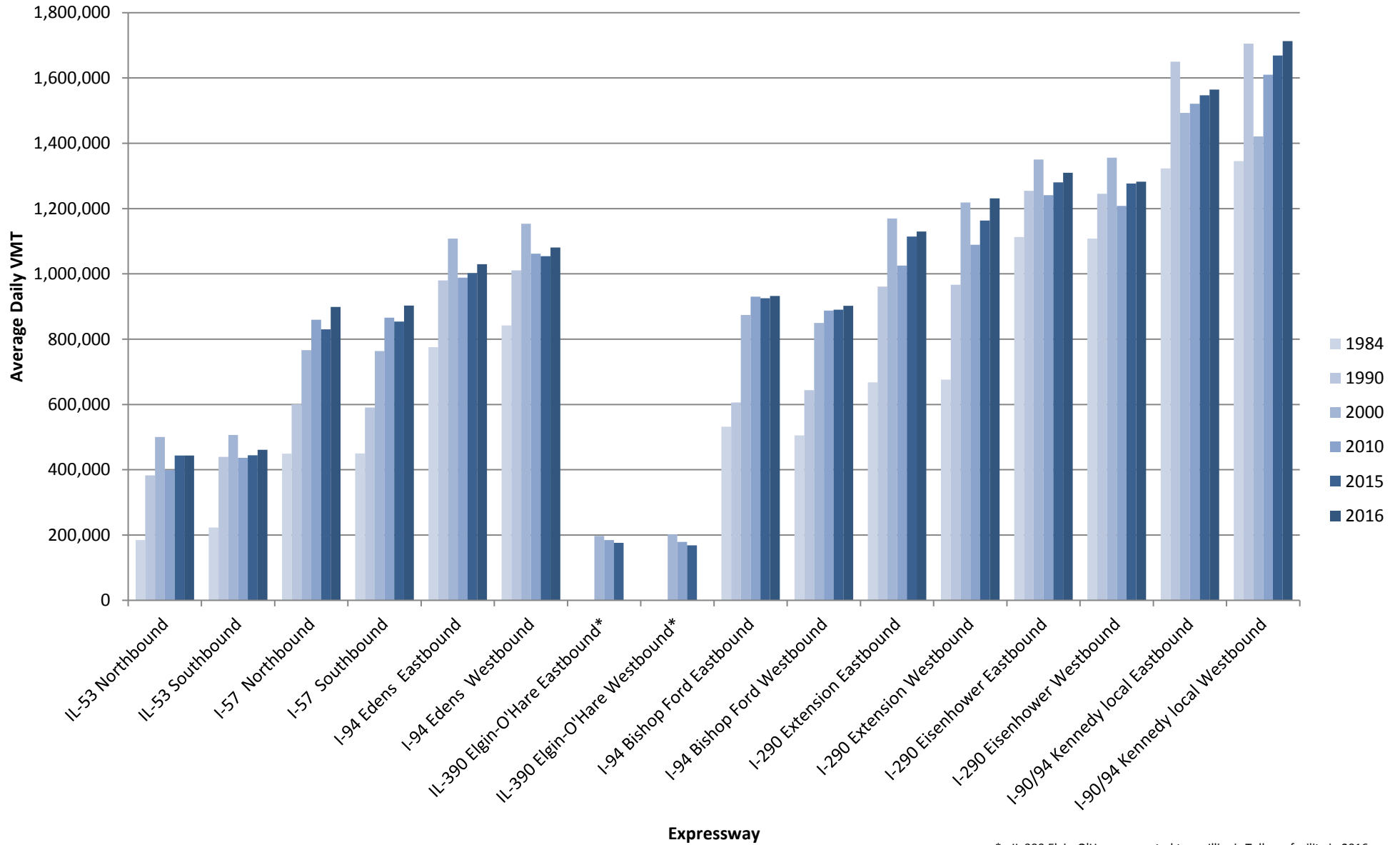

\* - IL-390 Elgin-O'Hare converted to an Illinois Tollway facility in 2016.

# IDOT Average Daily Expressway Vehicle Miles Traveled (VMT) 1984, 1990, 2000, 2010, & 2015-2016

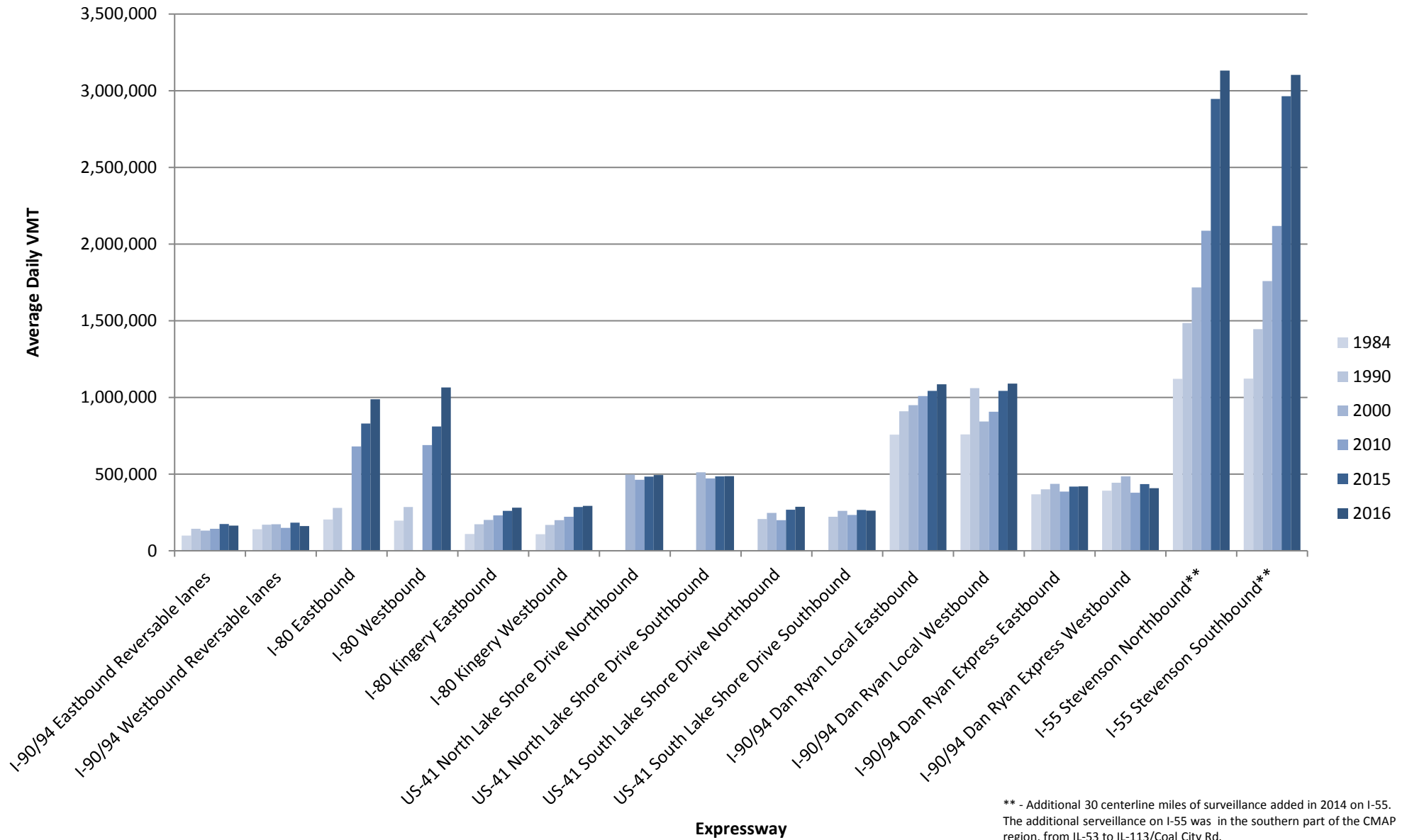

\*\* - Additional 30 centerline miles of surveillance added in 2014 on I-55. The additional surveillance on I-55 was in the southern part of the CMAP region, from IL-53 to IL-113/Coal City Rd.



# 2016 Expressway Atlas

## Part 2: Traffic flow graphics by expressway segment





**FLOW MAP INDEX**

<b>FACILITY</b>	<b>DESIGNATION(S)</b>	<b>FROM</b>	<b>TO</b>	<b>PAGE(S)</b>
Stevenson Expressway	I-55	Illinois Route 113	U.S. Route 41/Lake Shore Drive	12 - 16
I-57 Expressway	I-57	Peotone Road	I-94 Dan Ryan Expressway	17 -18
I-80 Expressway	I-80	Richards Road	I-294 Tri-State Tollway	19
Kingery Expressway	I-80 & I-94	I-94 Bishop Ford Freeway	Indiana State Line	20
Dan Ryan Expressway	I-90 & I-94	I-290 Eisenhower Expressway	I-57 Expressway/I-94 Bishop Ford Freeway	21 - 24
Kennedy Expressway	I-90 & I-94 & I-190	Bessie Coleman Drive	I-290 Eisenhower Expressway	25 - 30
Bishop Ford Freeway	I-94 & Illinois Route 394	Illinois Route 394	I-94 Dan Ryan Expressway	31 - 32
Edens Expressway	I-94	Clavey Road	I-90 Kennedy Expressway	33 - 34
Eisenhower Expressway	I-290	Wolf Road	Wacker Dr./Franklin St.	35 - 39
I-290 Extension	I-290 & Illinois Route 53	I-90 Jane Addams Tollway	I-290 Eisenhower Expressway	40 - 42
Illinois Route 53	Illinois Route 53	Lake-Cook Road	Illinois Route 62/Algonquin Road	43
North Lake Shore Drive	U.S. Route 41	Hollywood Avenue	Balbo Drive	44 - 45
South Lake Shore Drive	U.S. Route 41	Roosevelt Road	Jefferey Boulevard	46 - 47

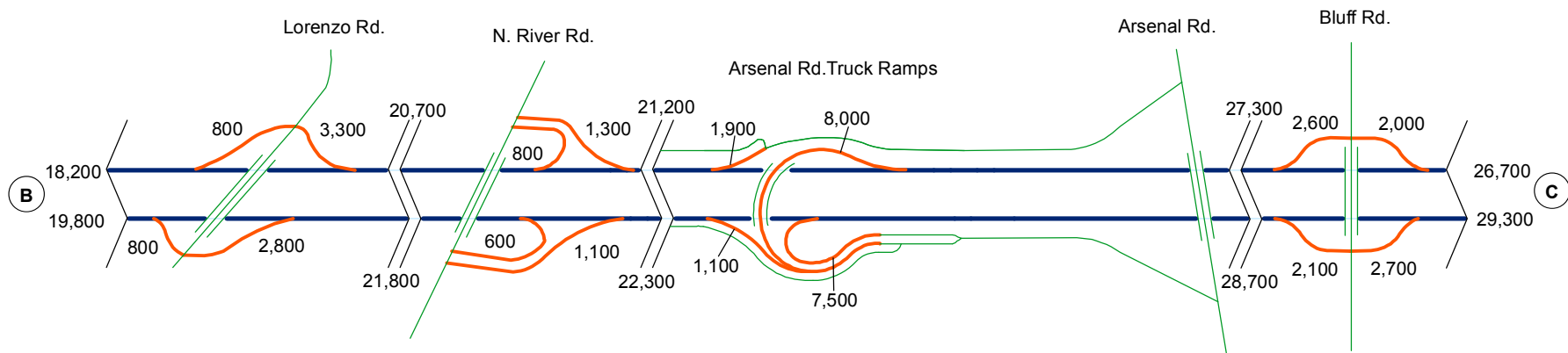
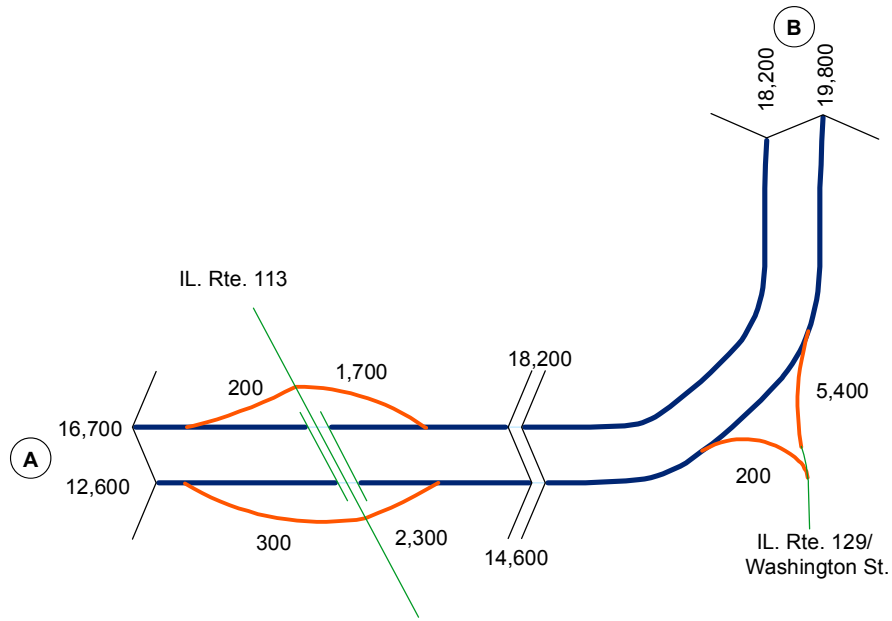

2016 Annual Average Daily Traffic

I-55/Stevenson Expressway, from IL. Rte. 113 To Bluff Rd.



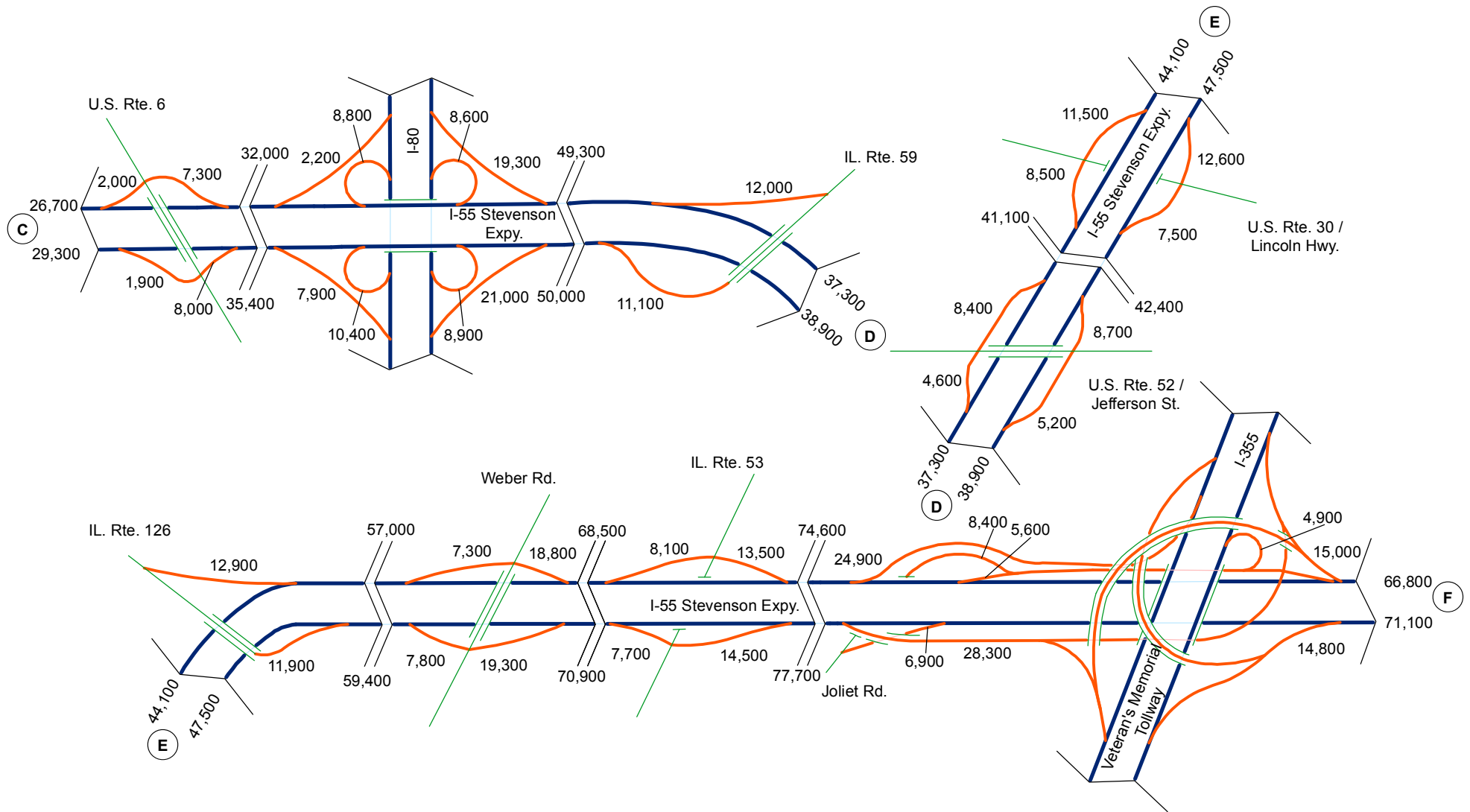

2016 Annual Average Daily Traffic

I-55 Stevenson Expressway, from U.S. Rte. 6 to I-355 Veteran's Memorial Toll.

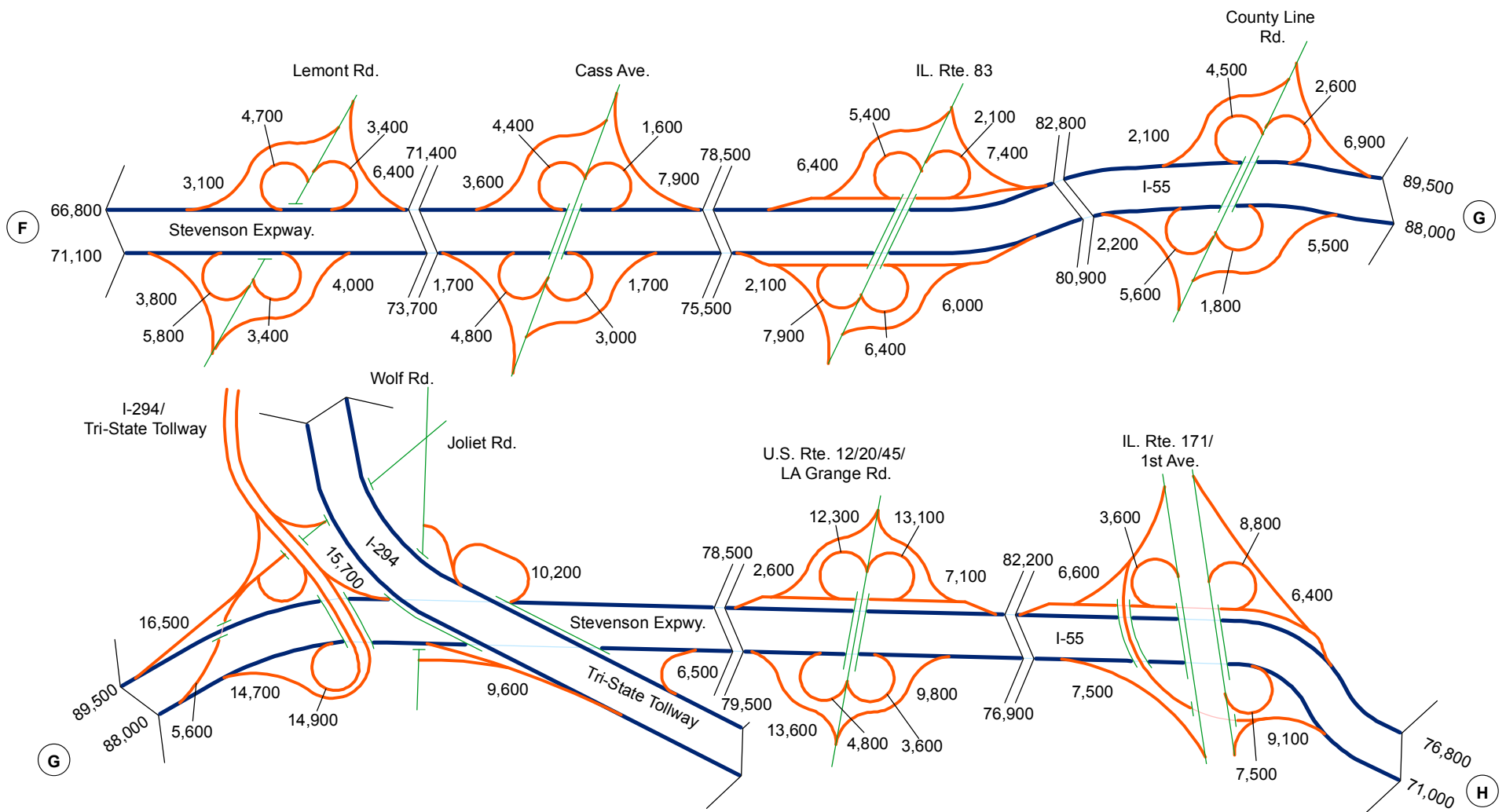

2016 Annual Average Daily Traffic

I-55 Stevenson Expressway, from Lemont Rd. to IL. Rte. 171/1st Ave.

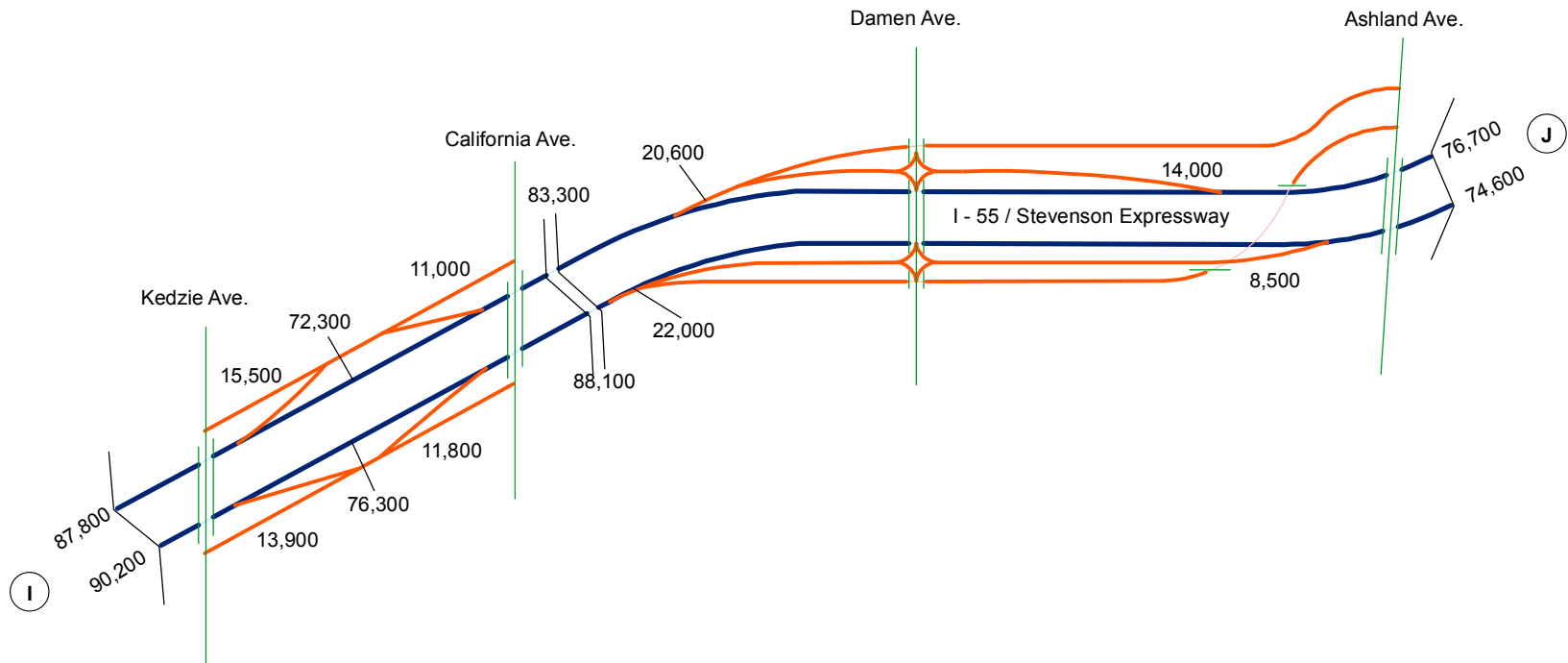
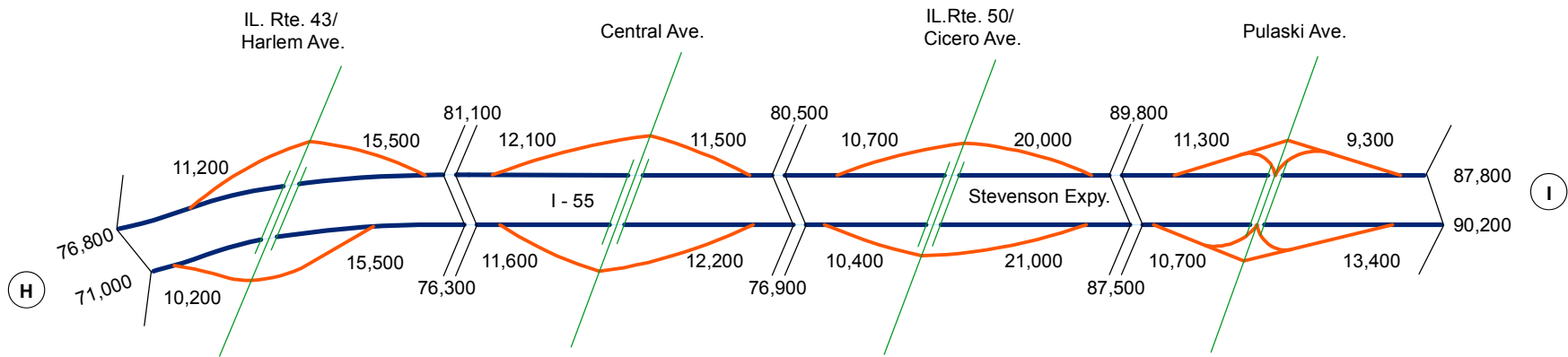

2016 Annual Average Daily Traffic

I-55 Stevenson Expressway, from IL. Rte. 43/Harlem Ave. to Ashland Ave.

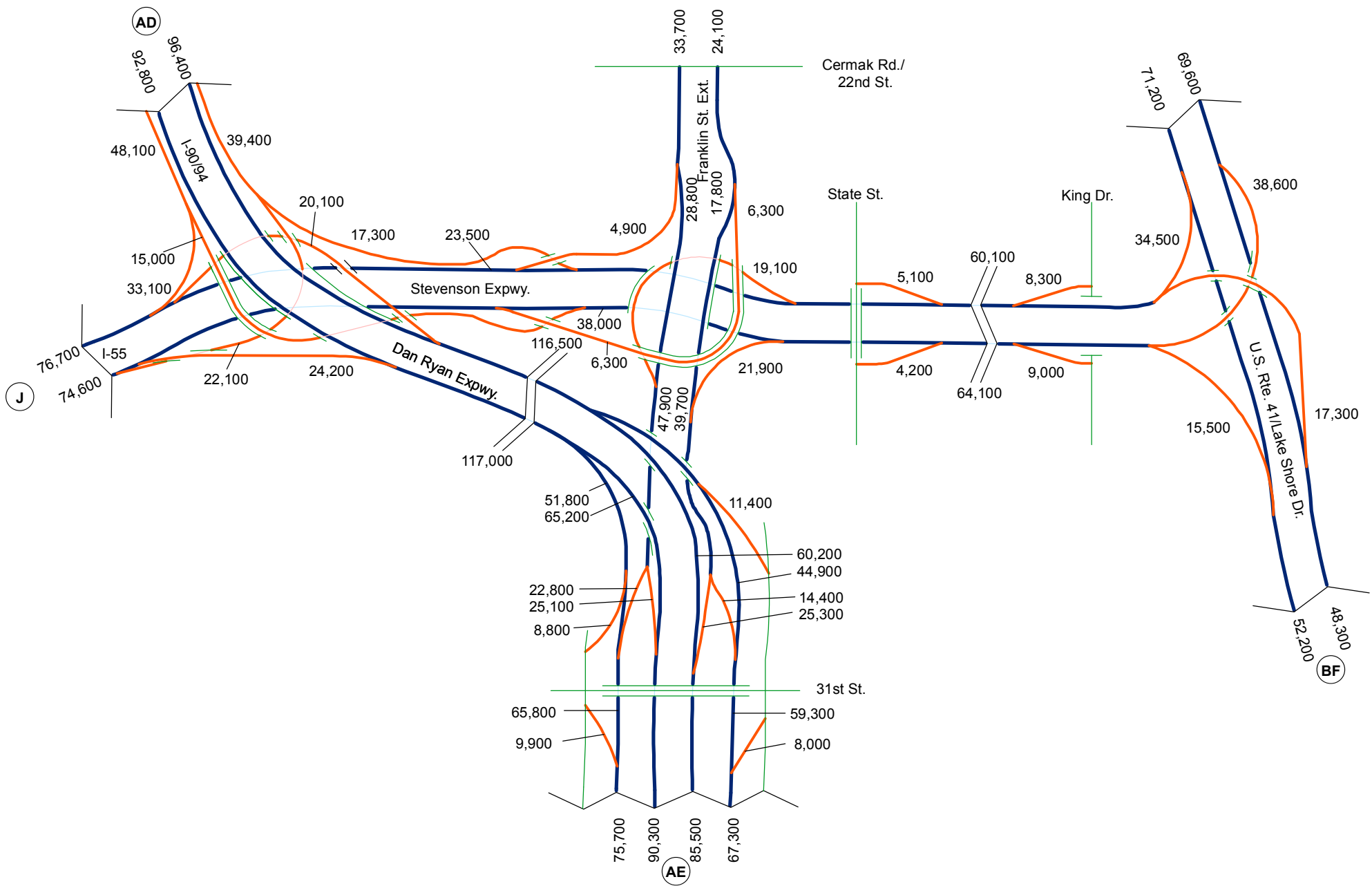

2016 Annual Average Daily Traffic

I-90/94 Dan Ryan Expressway, from I-55 Stevenson Expwy. to 31st St./Franklin St. Ext.



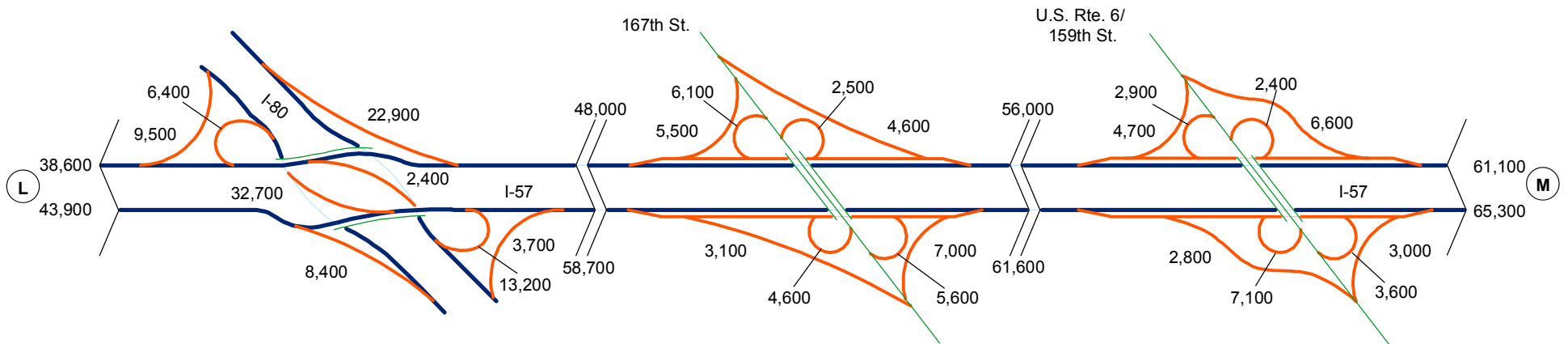
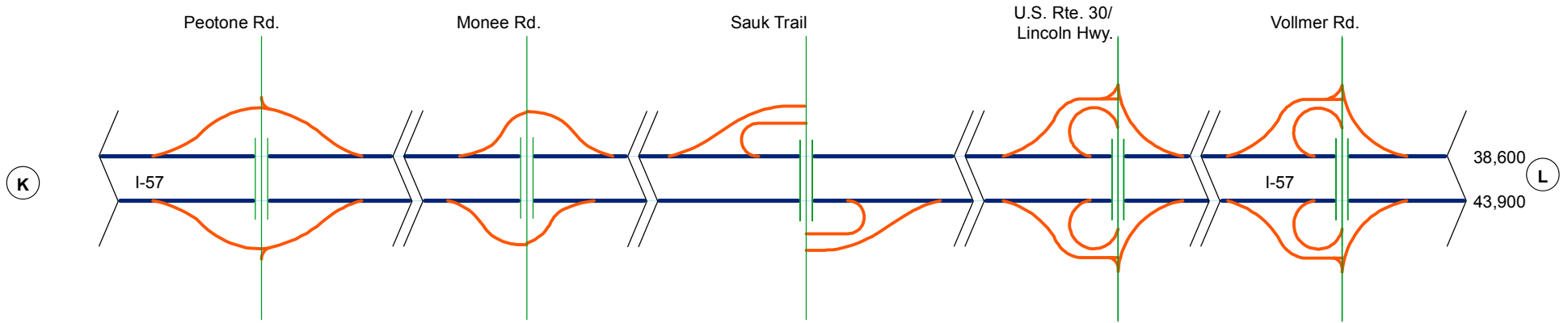

2016 Annual Average Daily Traffic

I-57 Expressway, from Peotone Rd. to U.S. Rte. 6/159th St.



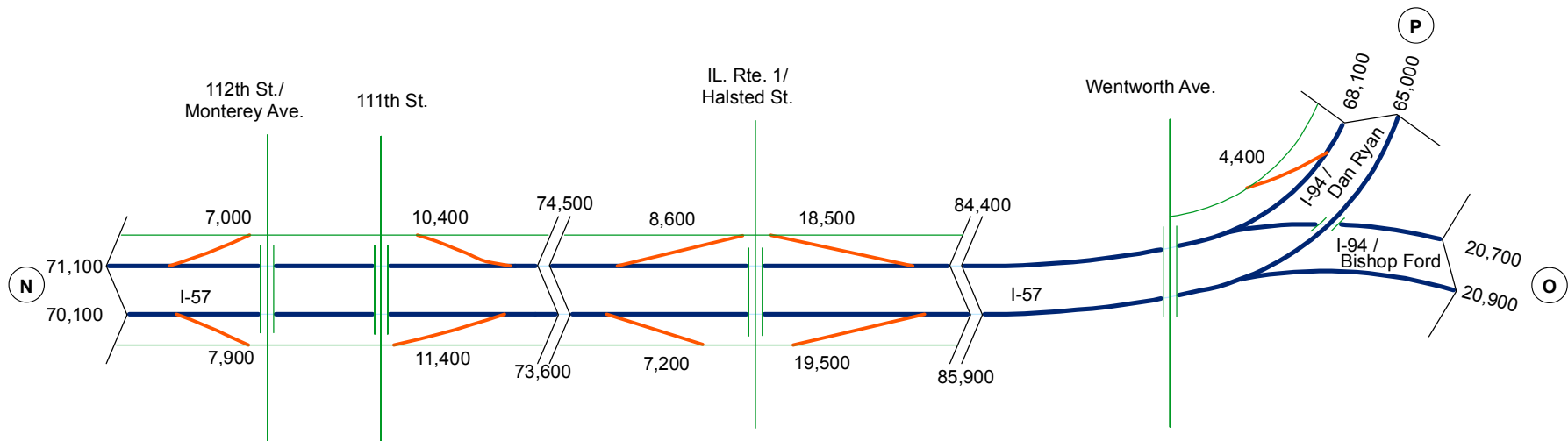
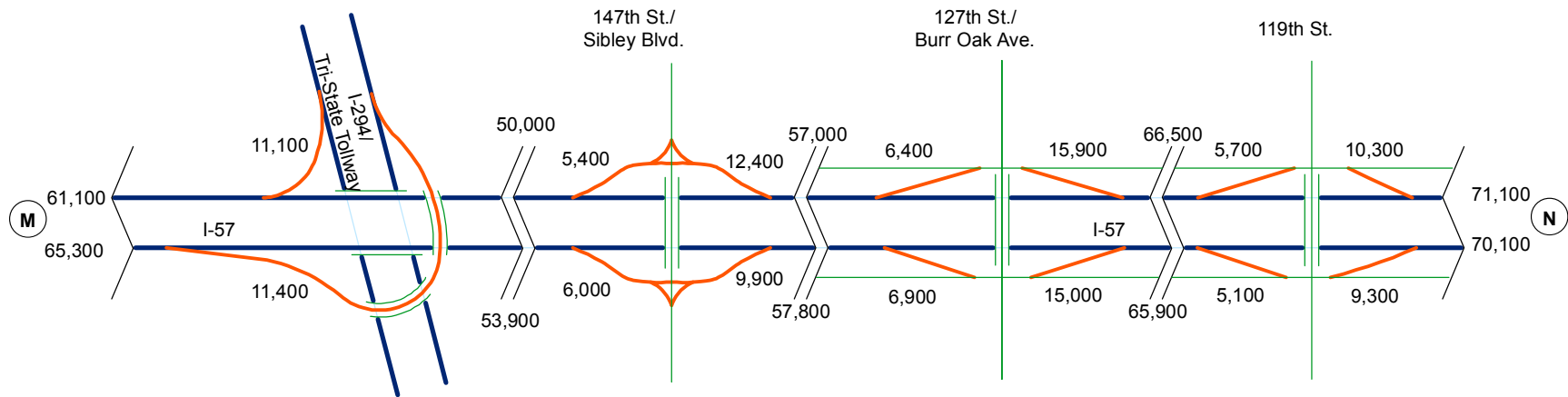

2016 Annual Average Daily Traffic

I-57 Expressway, from I-294/Tri-State Tollway to I-94 Dan Ryan Expwy./Bishop Ford Frwy.

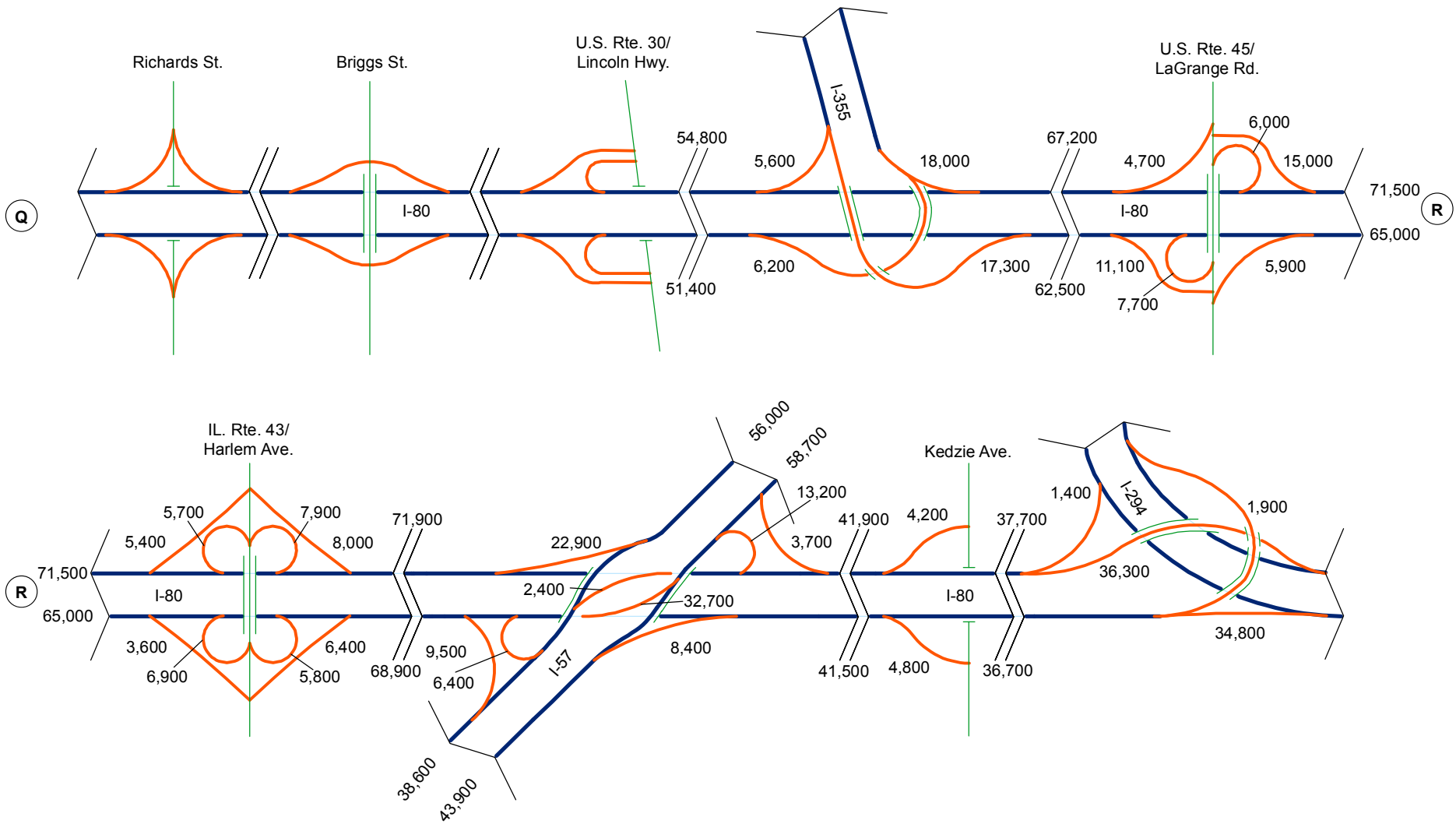

2016 Annual Average Daily Traffic

I-80 Expressway, from Richards St. to I-294 Tri-State Toll.

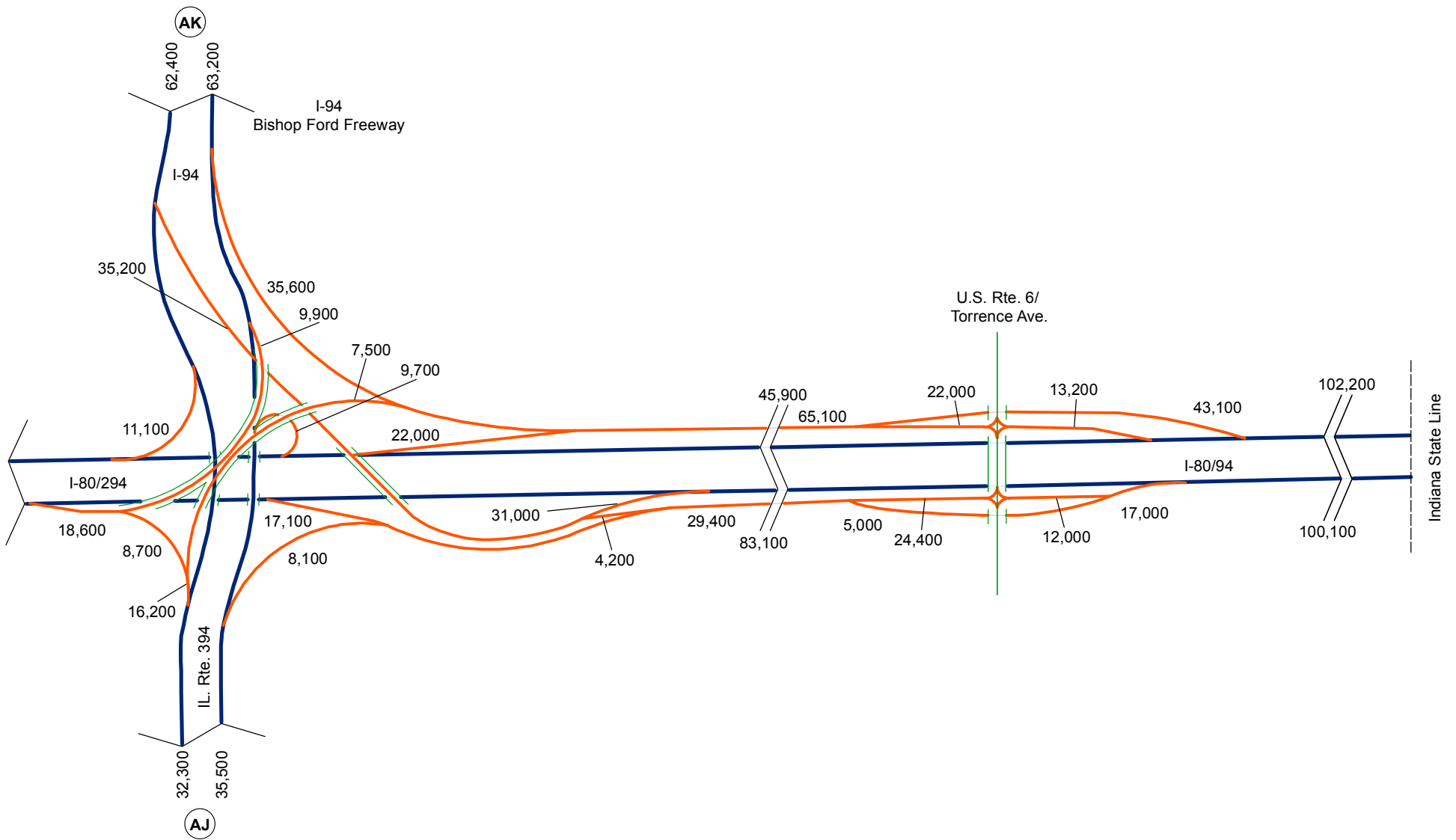

2016 Annual Average Daily Traffic

I-80/94 Kingery Expressway, from I-94 Bishop Ford Frwy. to Indiana state line



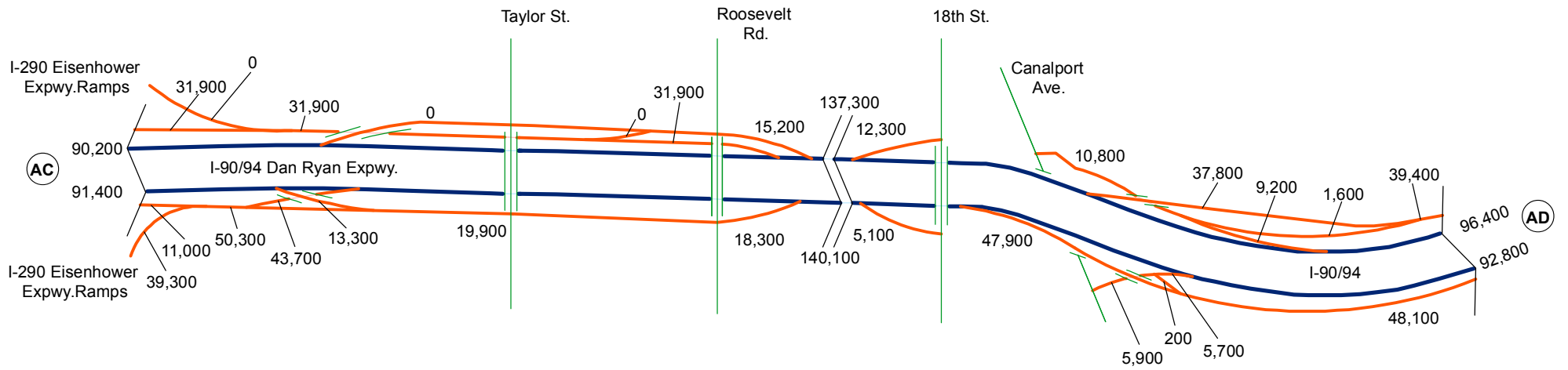

2016 Annual Average Daily Traffic

I-90/94 Dan Ryan Expressway, from I-290 Eisenhower Expwy. to Canalport Ave.



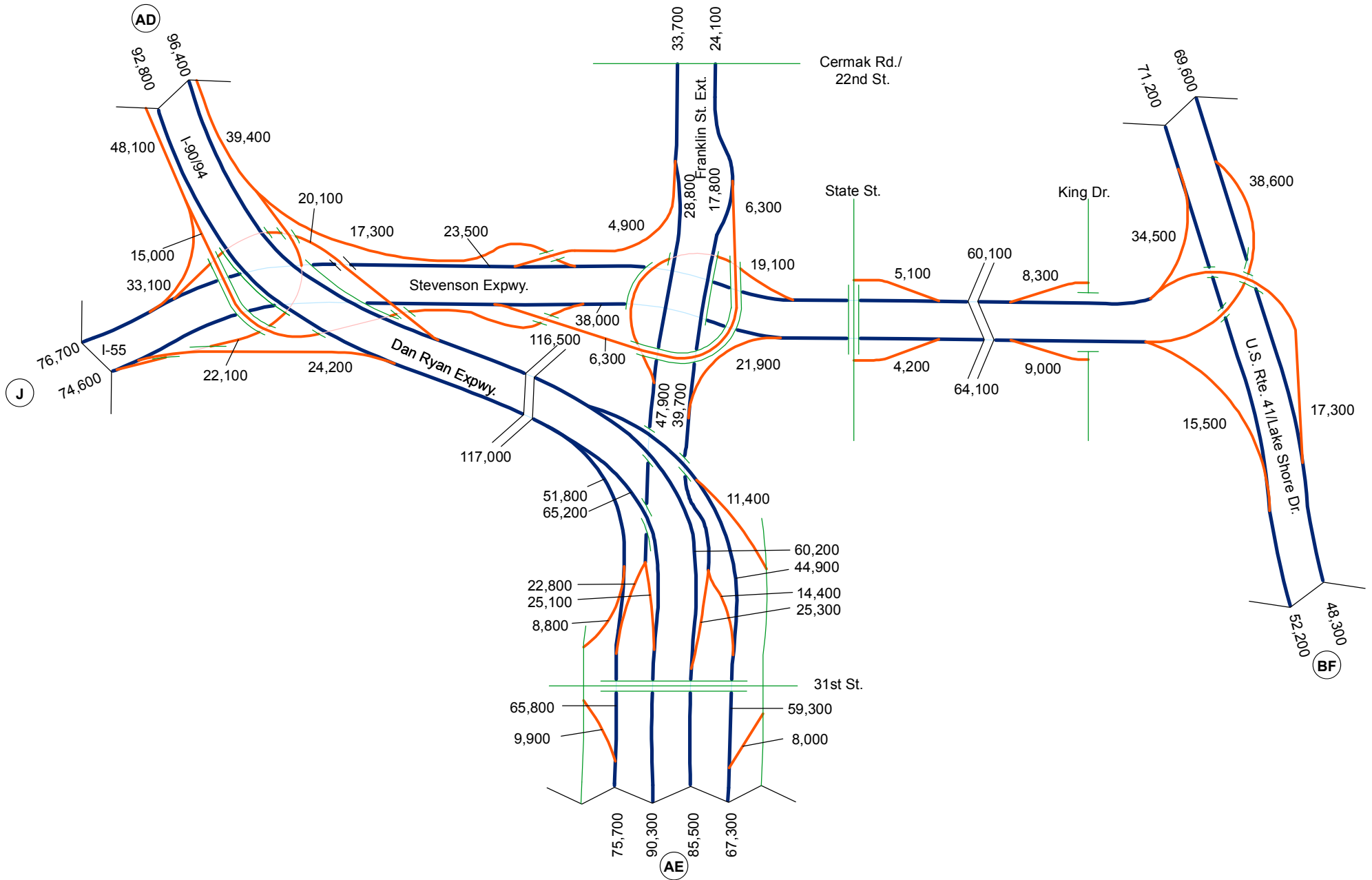

2016 Annual Average Daily Traffic

I-90/94 Dan Ryan Expressway, from I-55 Stevenson Expwy. to 31st St./Franklin St. Ext.



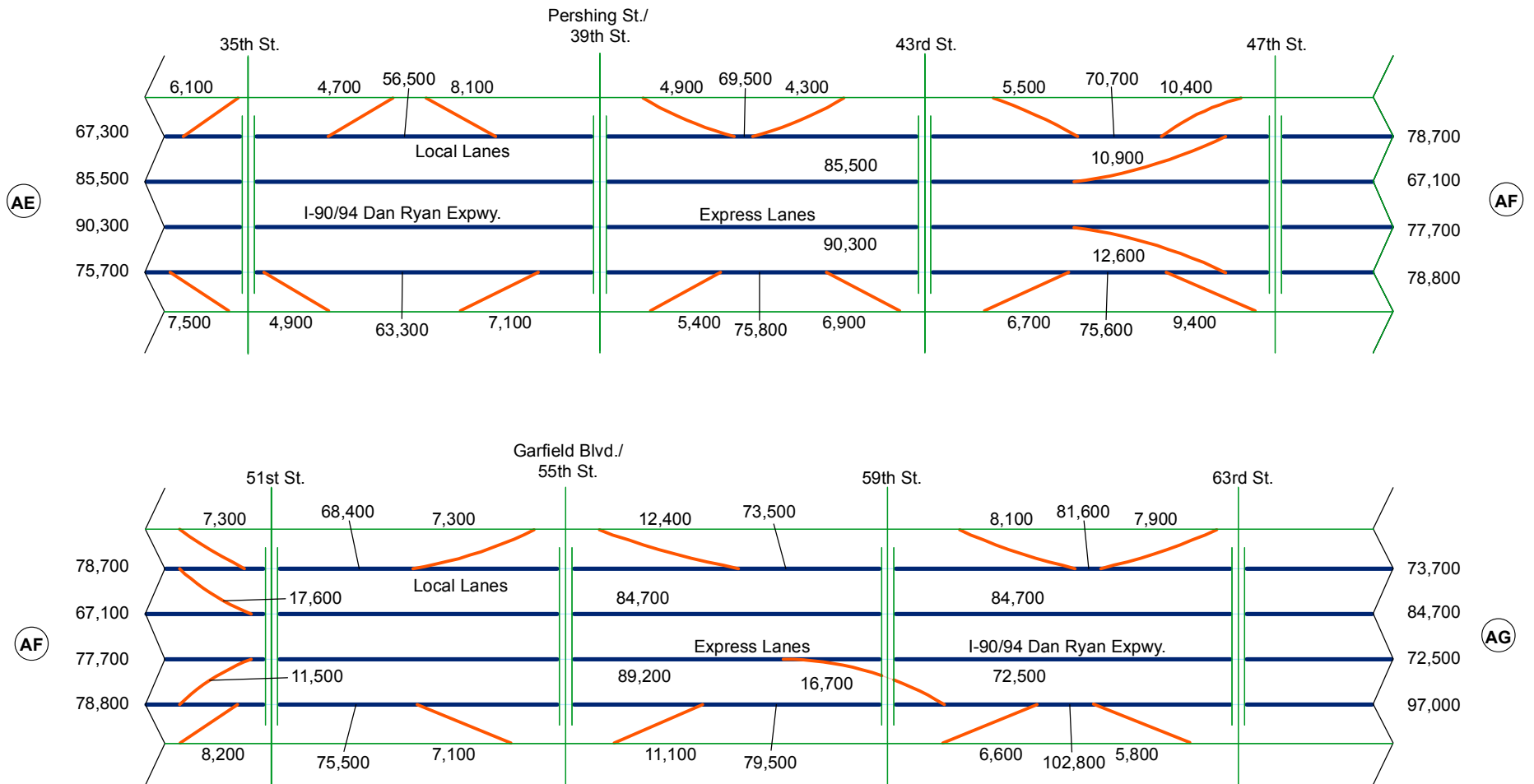

2016 Annual Average Daily Traffic

I-90/94 Dan Ryan Expressway, from 35th. St. to 63rd. St.



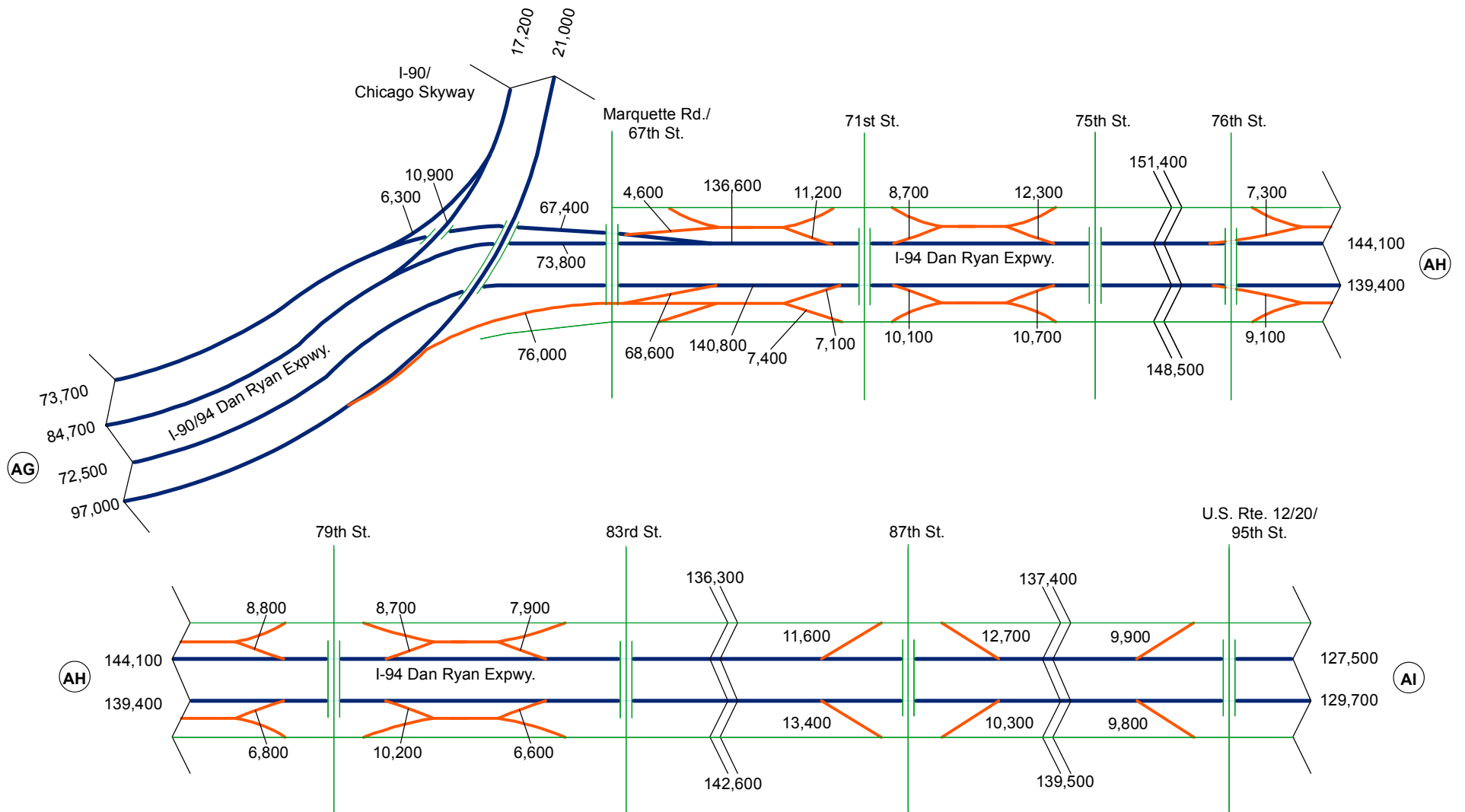

2016 Annual Average Daily Traffic

I-94 Dan Ryan Expressway, from I-90 Chicago Skyway to U.S. Rte. 12/20/95th St.

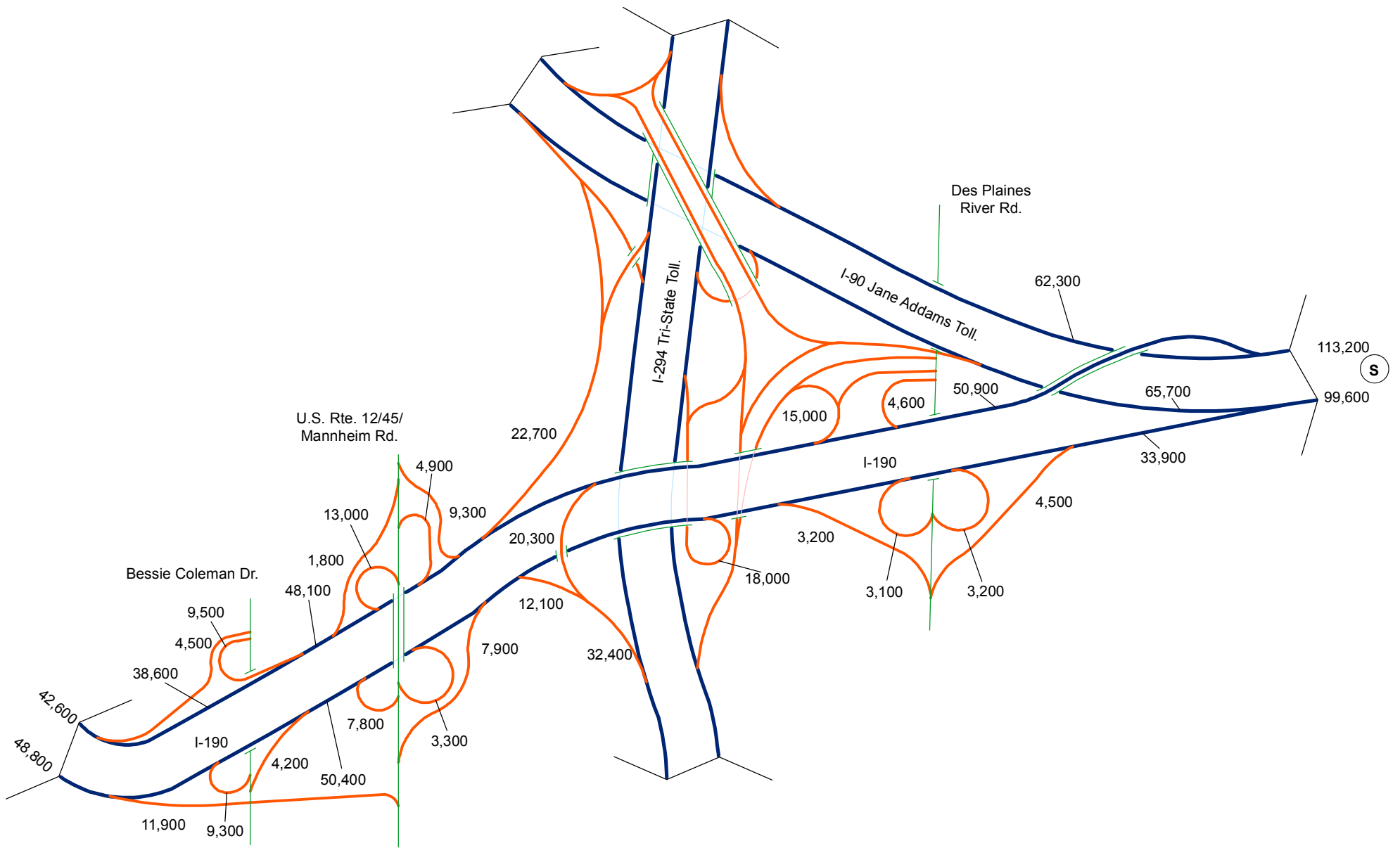

2016 Annual Average Daily Traffic

I-190 Kennedy Expressway, from Bessie Coleman Dr. to I-90 Jane Addams Toll.

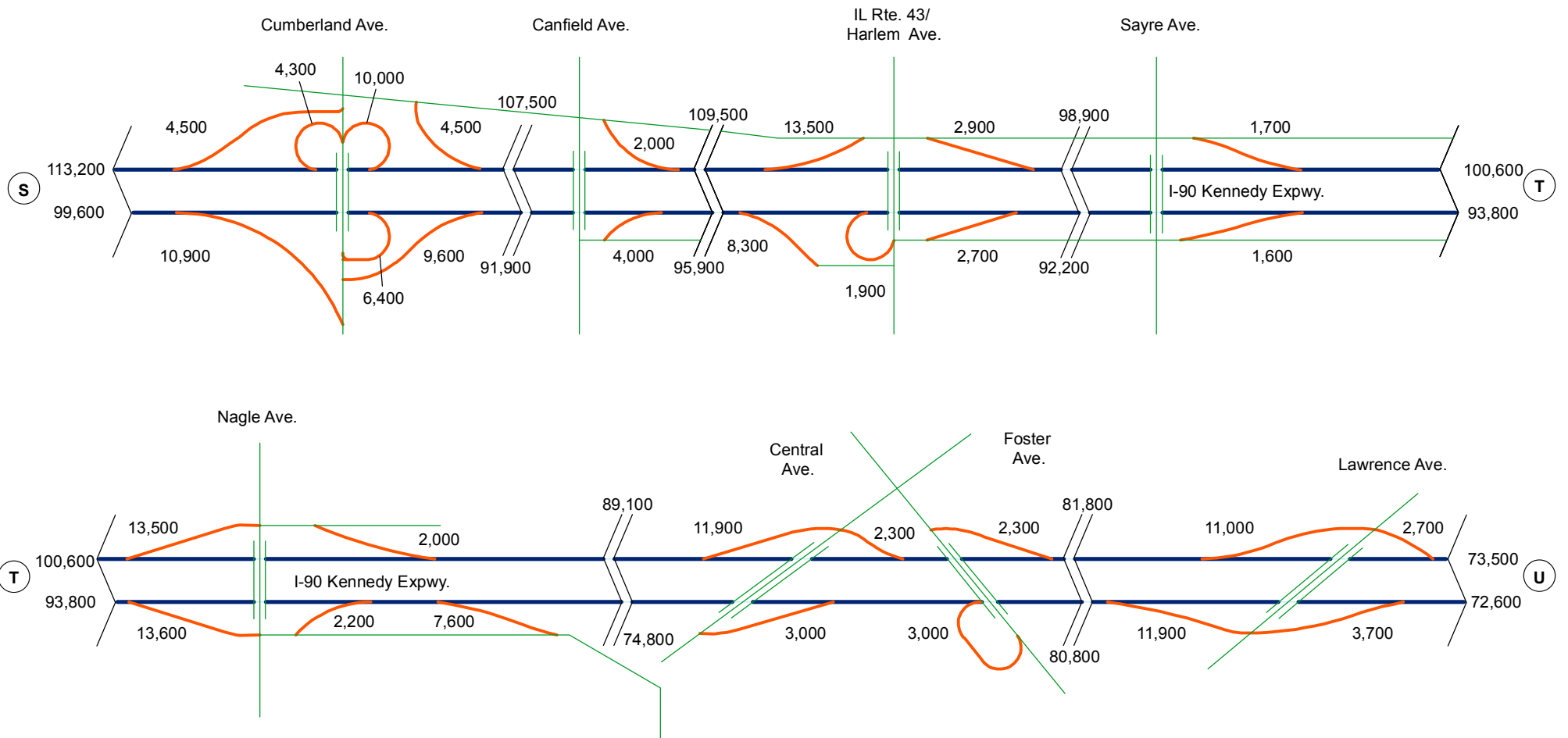

2016 Annual Average Daily Traffic

I-90 Kennedy Expressway, from Cumberland Ave. to Lawrence Ave.

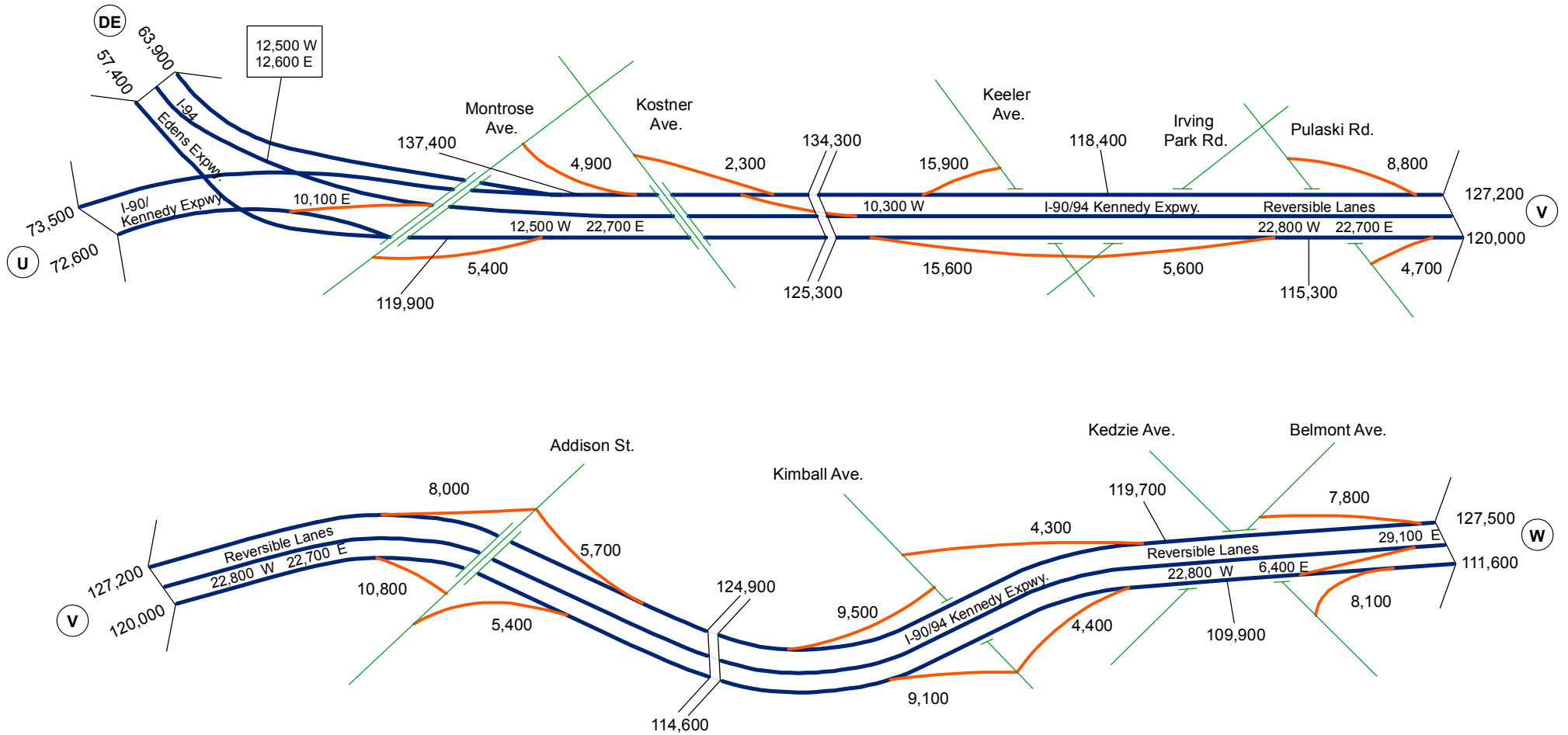

2016 Annual Average Daily Traffic

I-90/94 Kennedy Expressway, from I-94 Edens Expwy. to Belmont Ave. and Kedzie Ave.

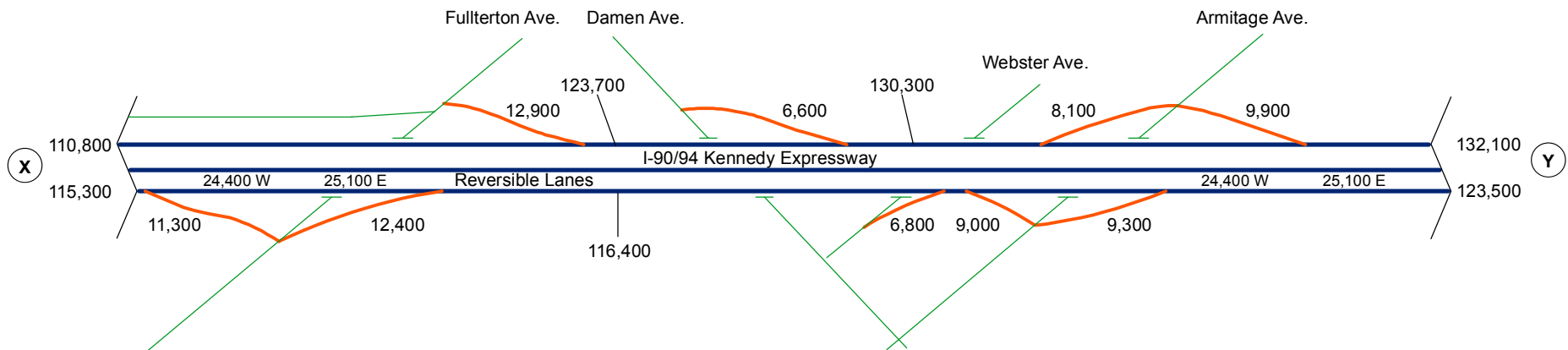
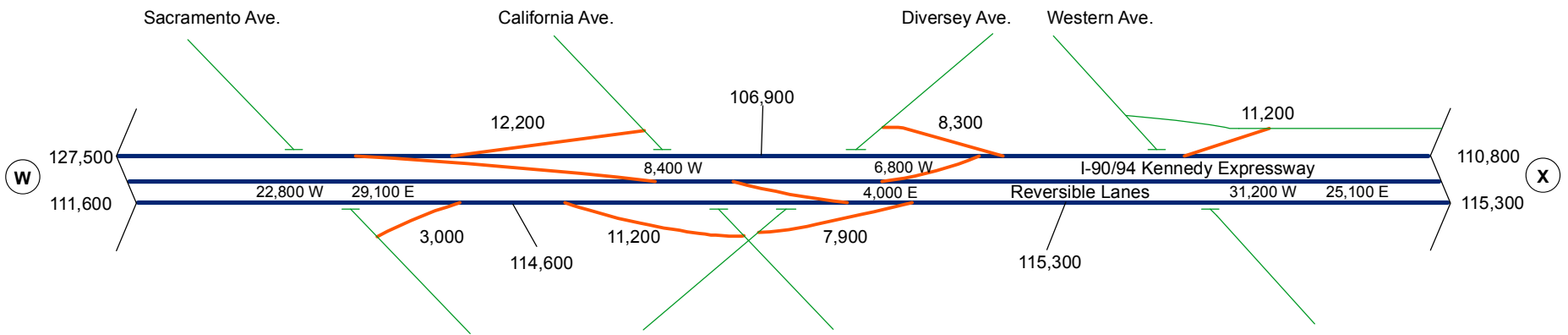

2016 Annual Average Daily Traffic

I-90/94 Kennedy Expressway, from Sacramento Ave. to Armitage Ave.



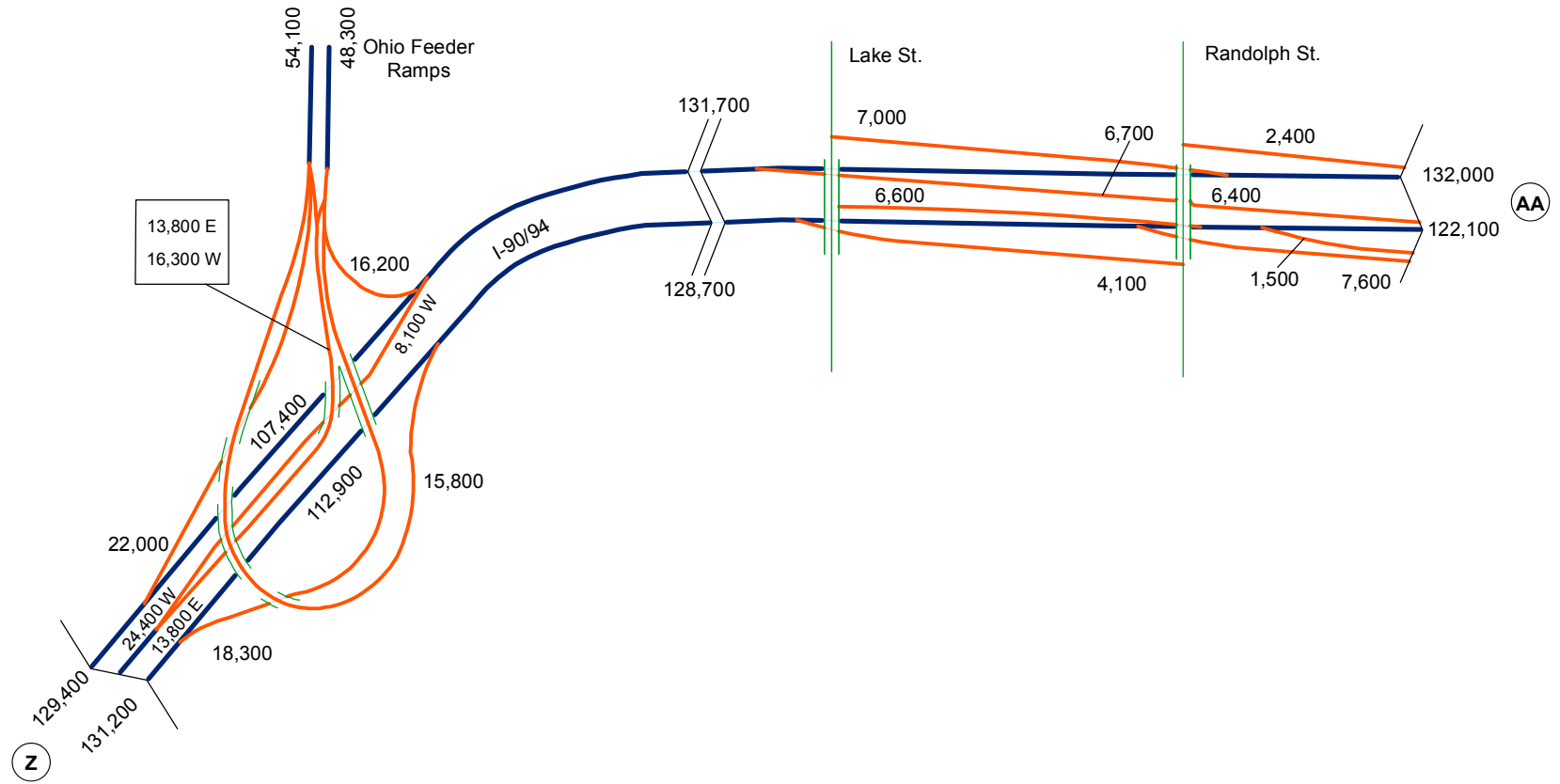
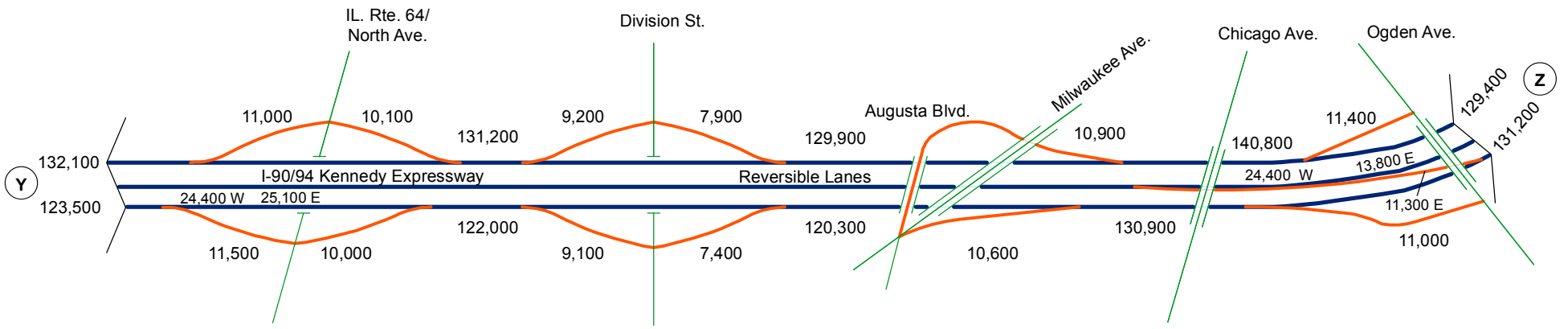

2016 Annual Average Daily Traffic

I-90/94 Kennedy Expressway, from IL. Rte. 64/North Ave. to Randolph St.

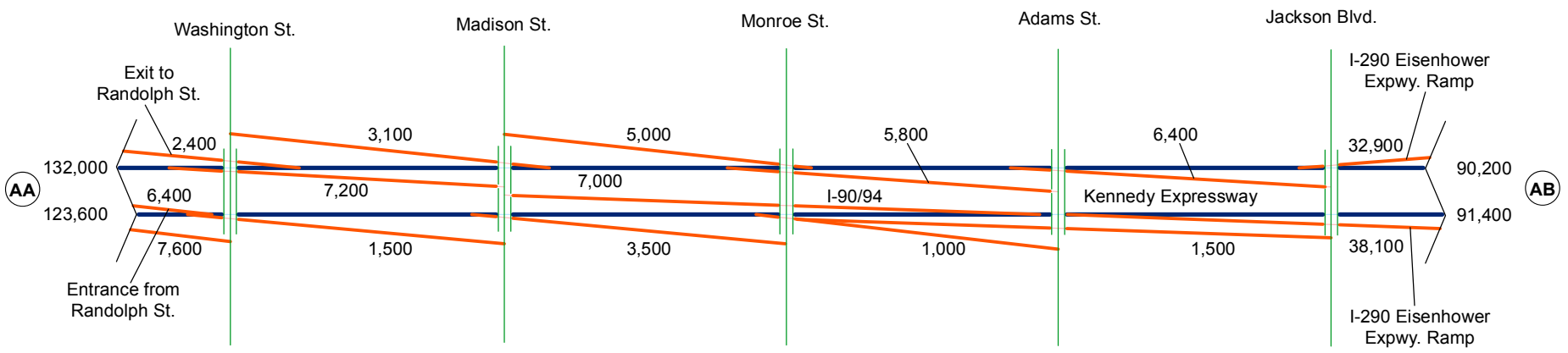

2016 Annual Average Daily Traffic

I-90/94 Kennedy Expressway, from Washington St. to Jackson Blvd.

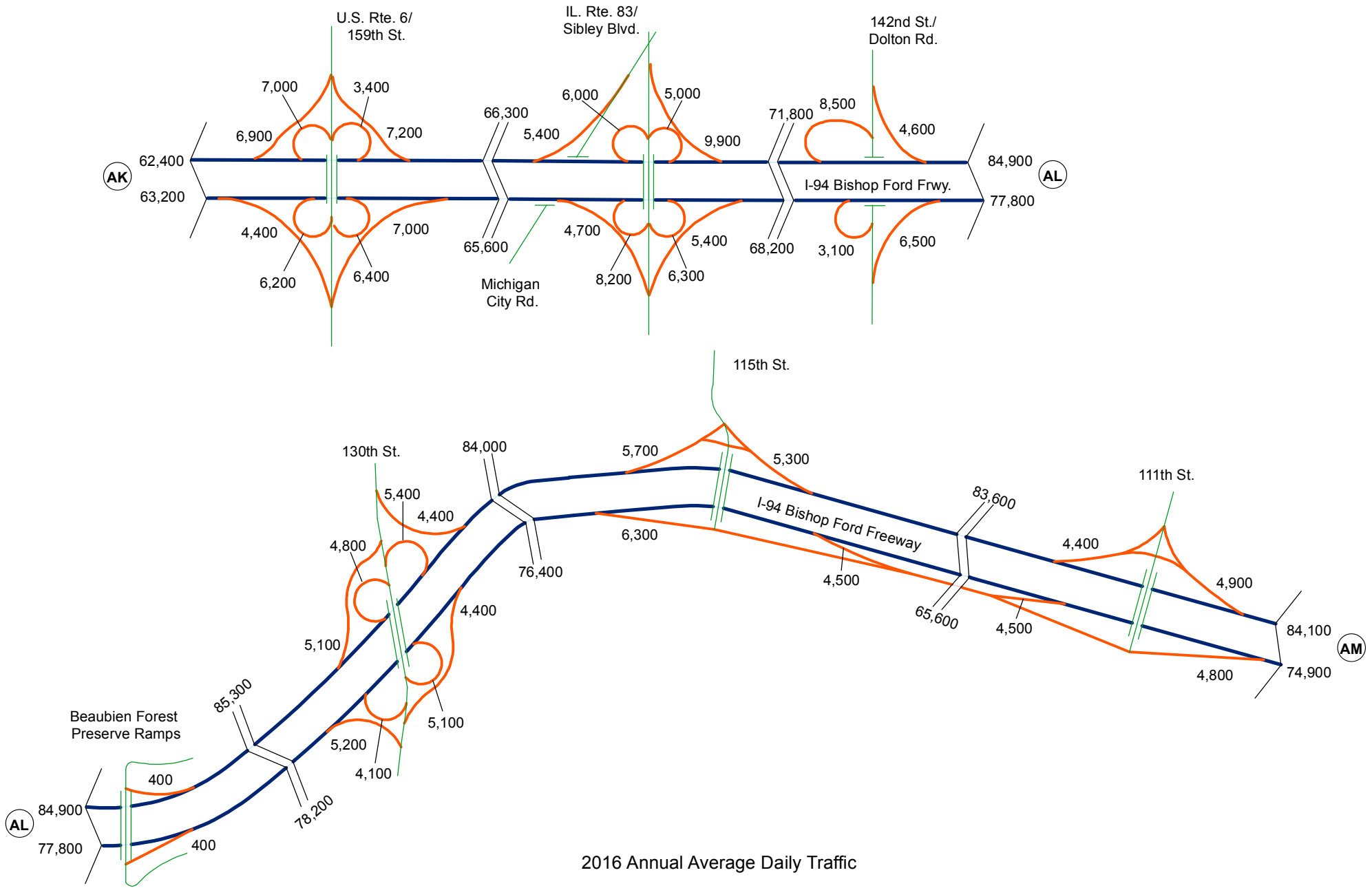

2016 Annual Average Daily Traffic

I-94 Bishop Ford Freeway, from U.S. Rte. 6/159th St. to 111th St.



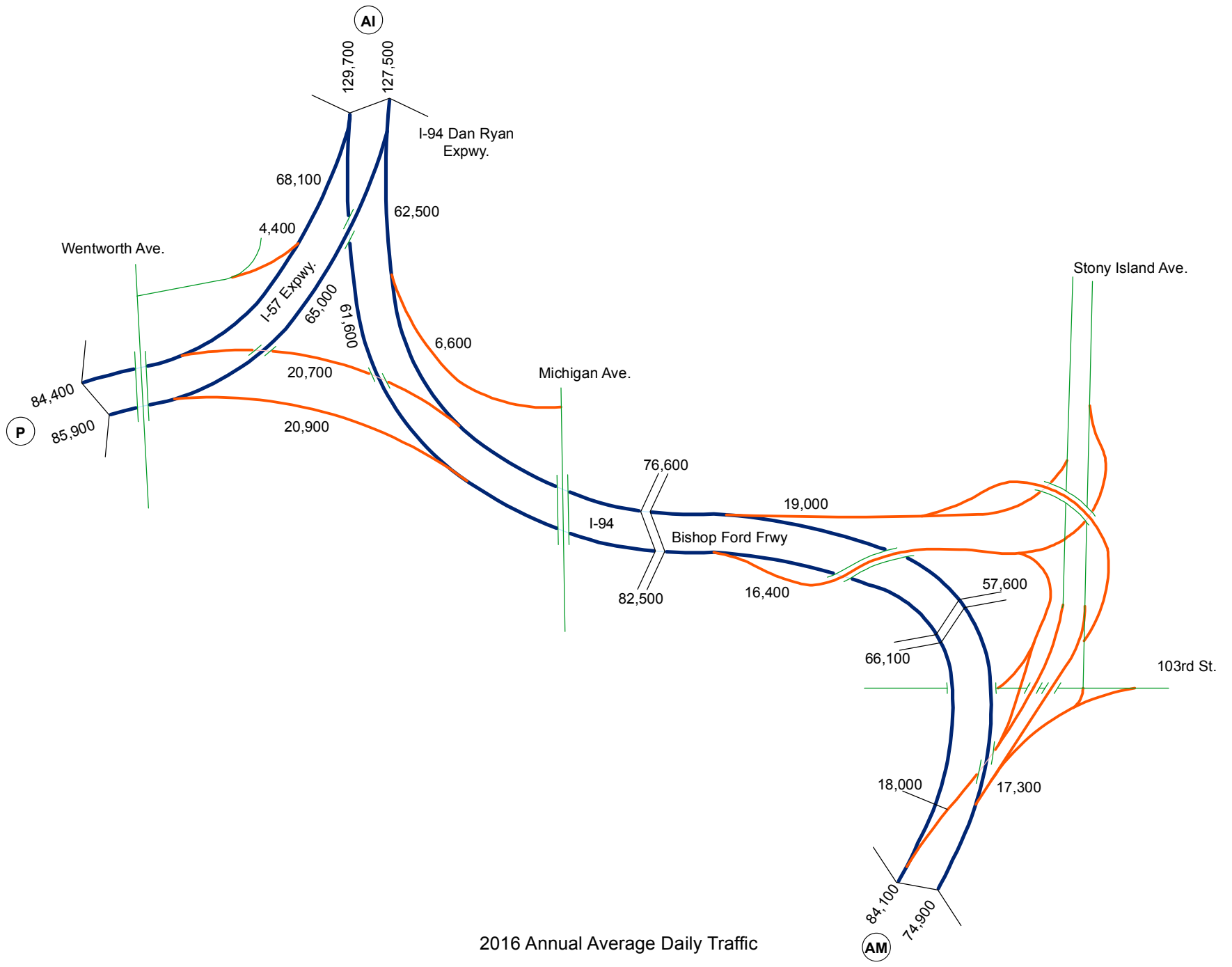

2016 Annual Average Daily Traffic

I-94 Bishop Ford Freeway, from 103rd St. to I-94 Dan Ryan and I-57 Expwys.

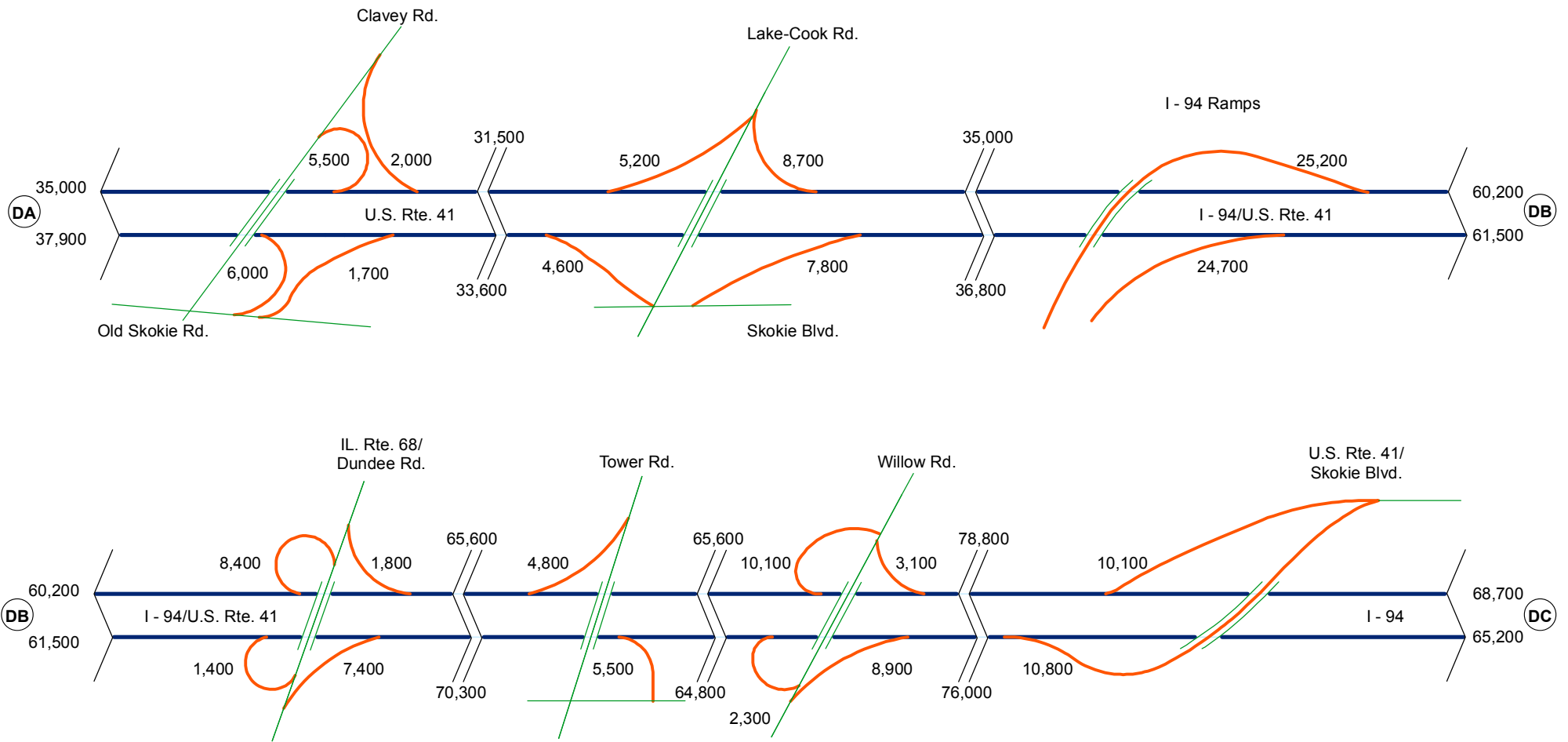

2016 Annual Average Daily Traffic

I-94 Edens Expressway, from Clavey Rd. to U.S. Rte. 41/Skokie Blvd.

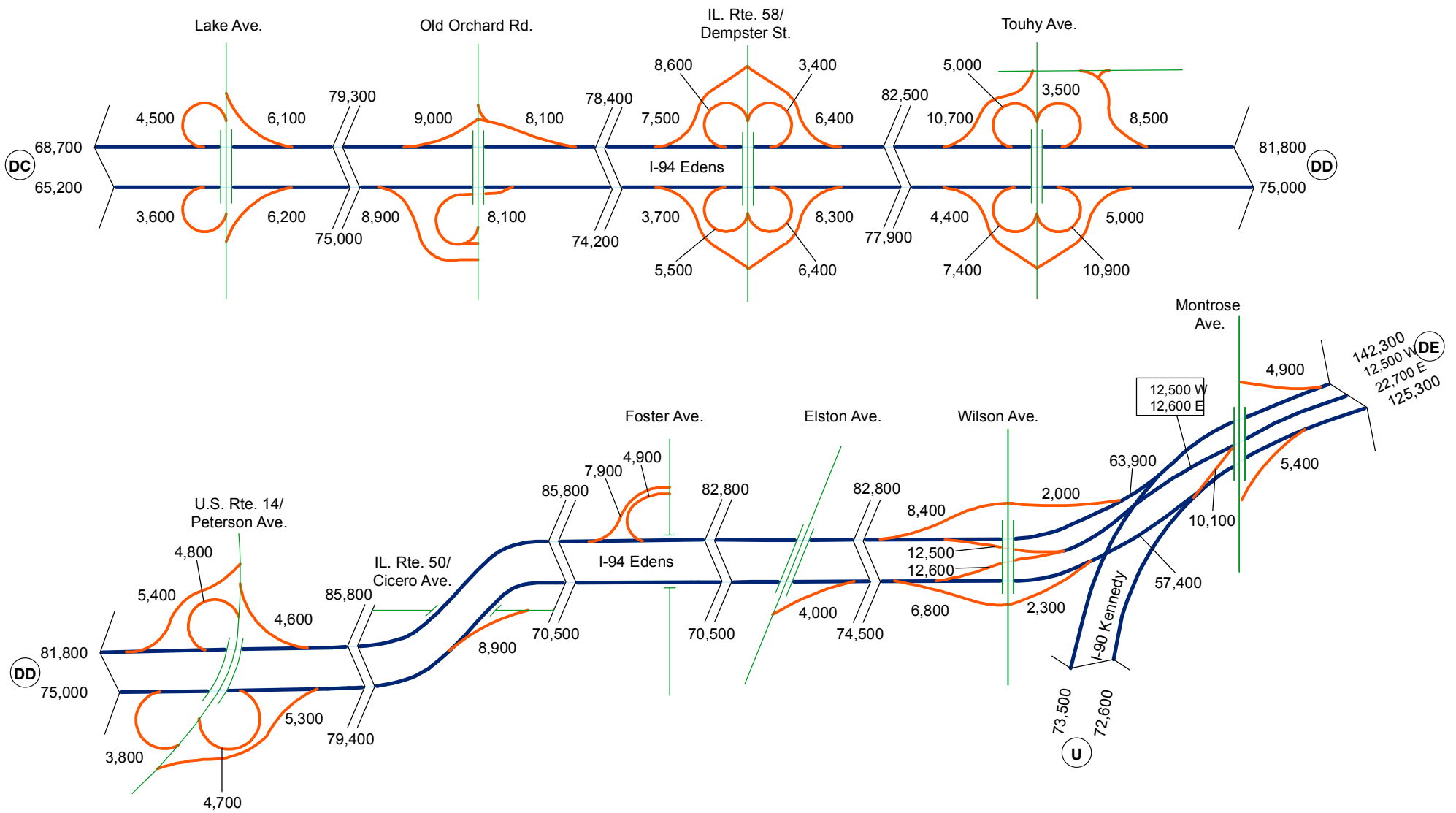

2016 Annual Average Daily Traffic

I-94 Edens Expressway, from Lake Ave. to I-90/Kennedy Expressway

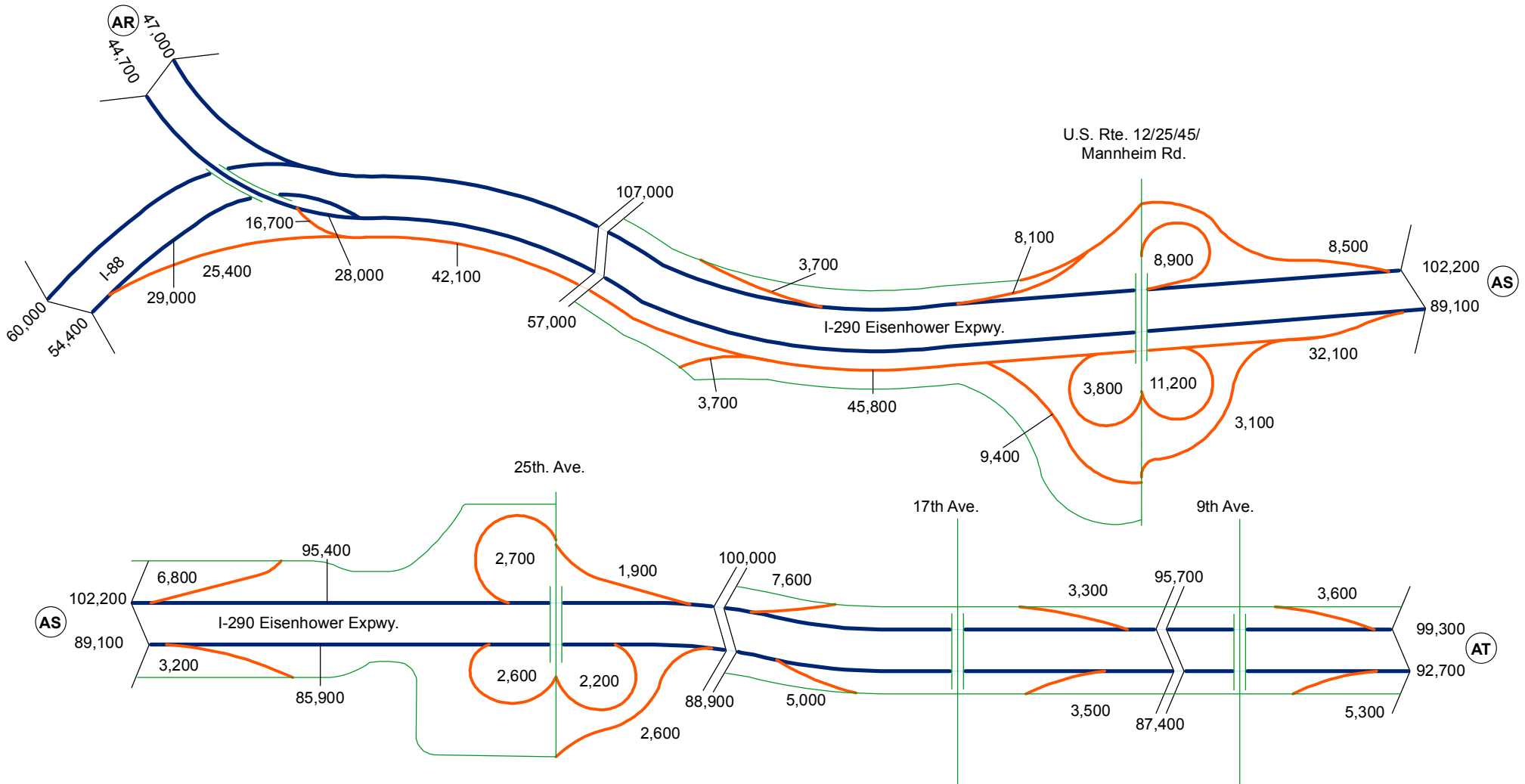

2016 Annual Average Daily Traffic

I-290 Eisenhower Expressway, from Wolf Rd. to 9th Ave.

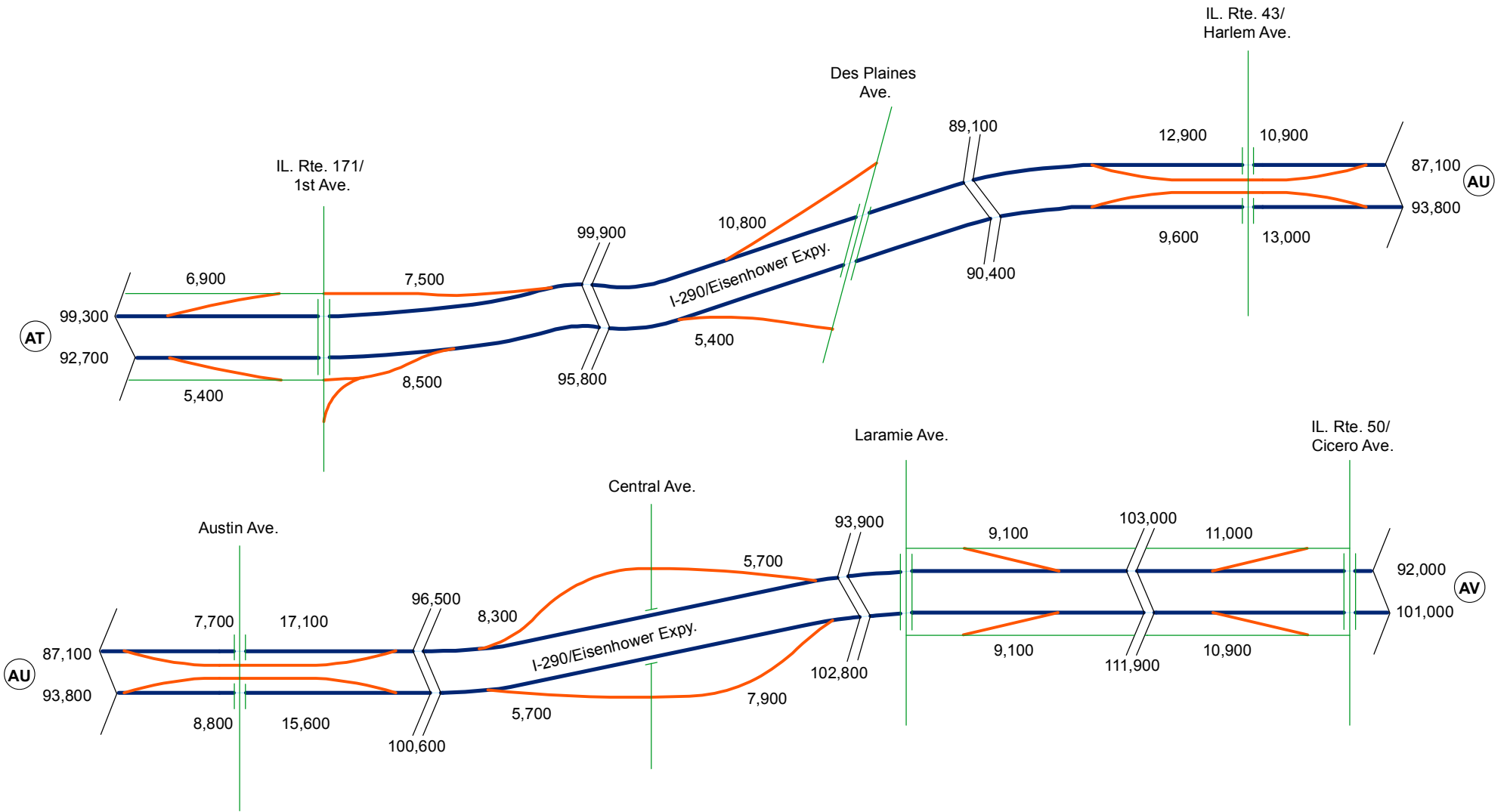

2016 Annual Average Daily Traffic

I-290 Eisenhower Expressway, from 1st. Ave. to IL. Rte. 50/Cicero Ave.





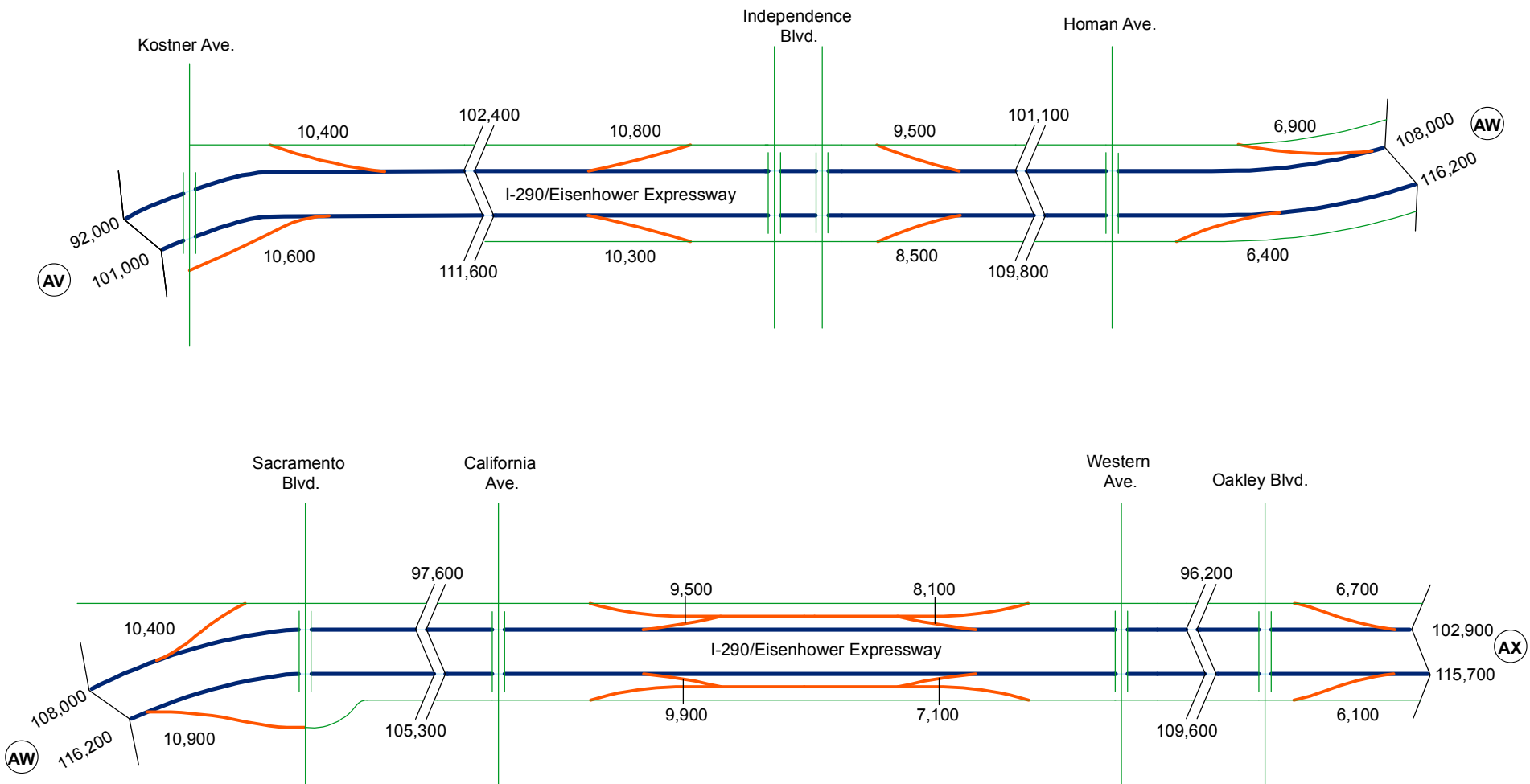

2016 Annual Average Daily Traffic

I-290 Eisenhower Expressway, from Kostner Ave. to Oakley Blvd.



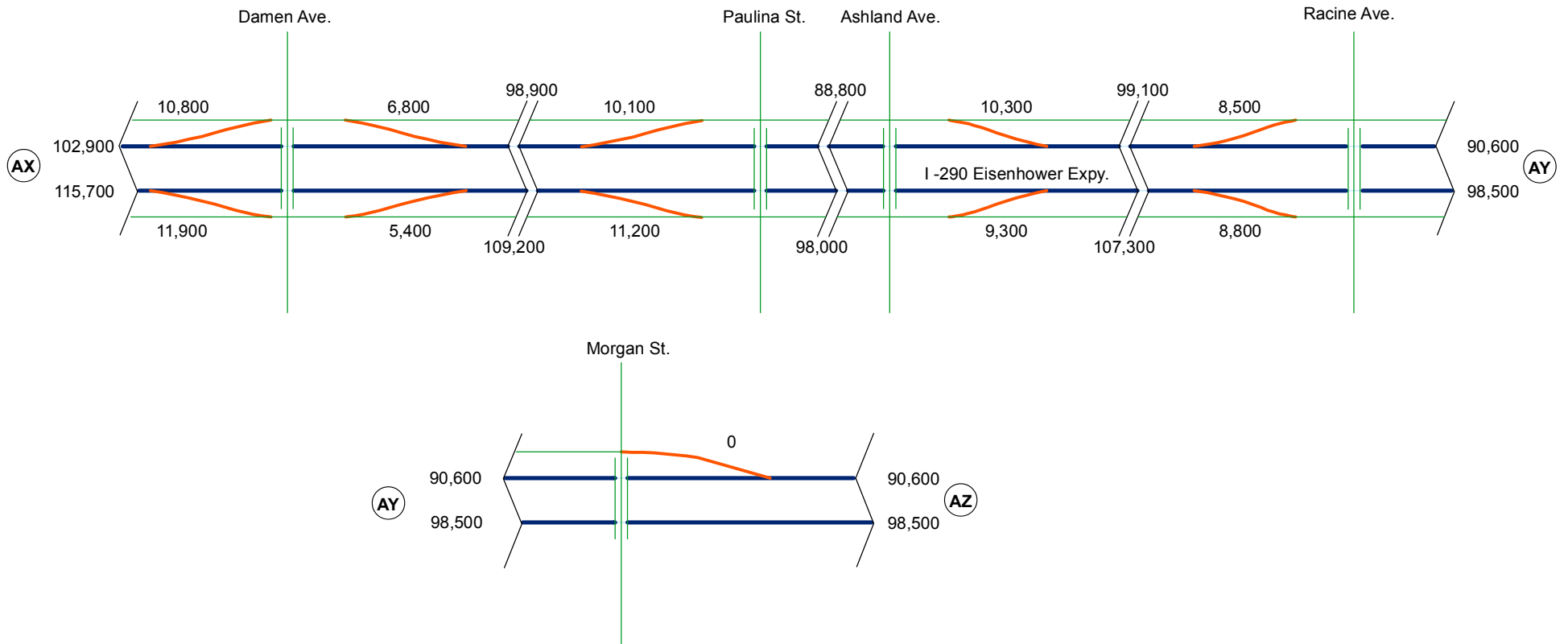

2016 Annual Average Daily Traffic  
I-290 Eisenhower Expressway, from Damen Ave. to Morgan St.

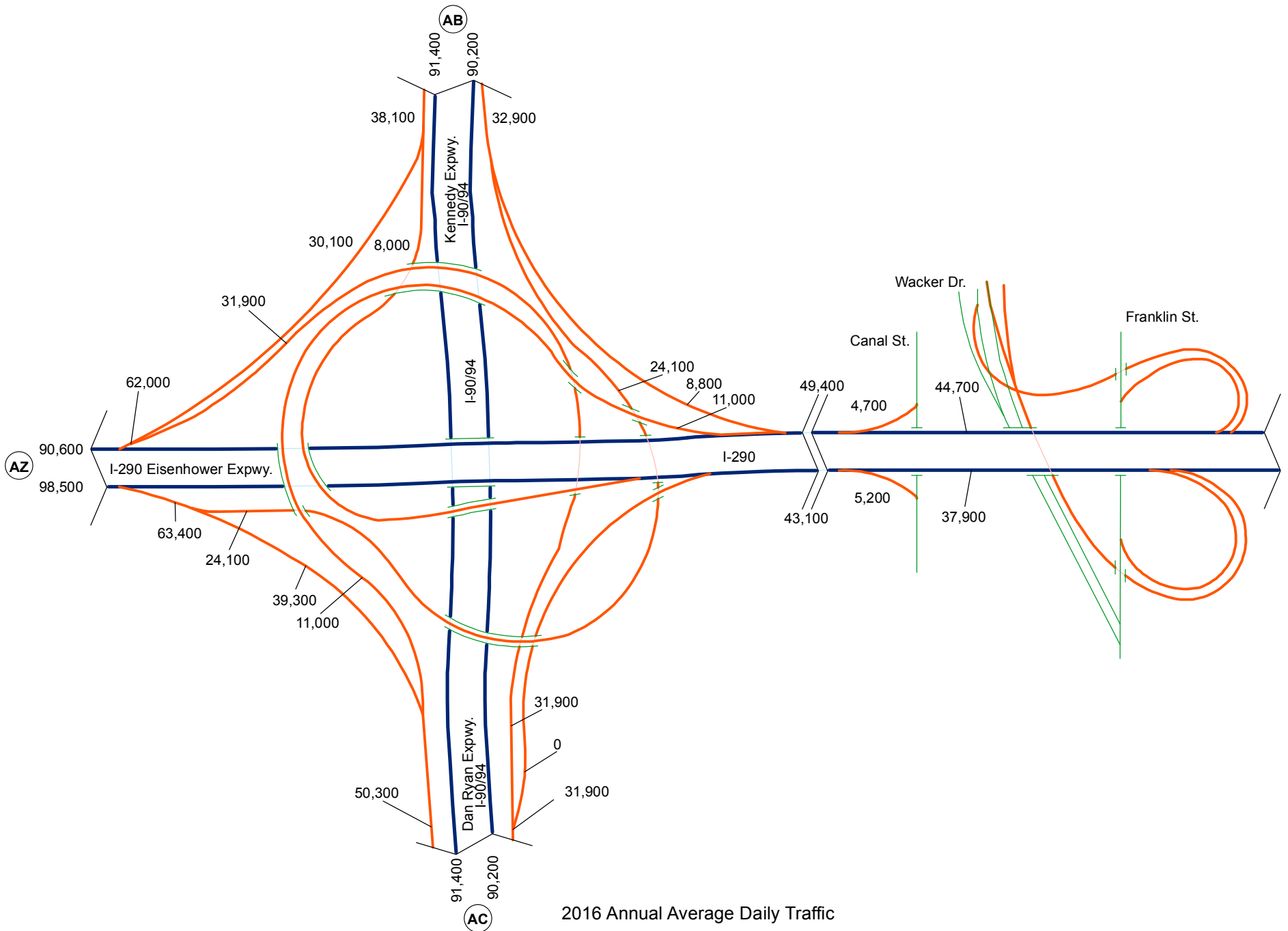

2016 Annual Average Daily Traffic

I-290 Eisenhower Expressway, from I-90/94 Kennedy/Dan Ryan Expressways to Wacker Dr./Franklin St.

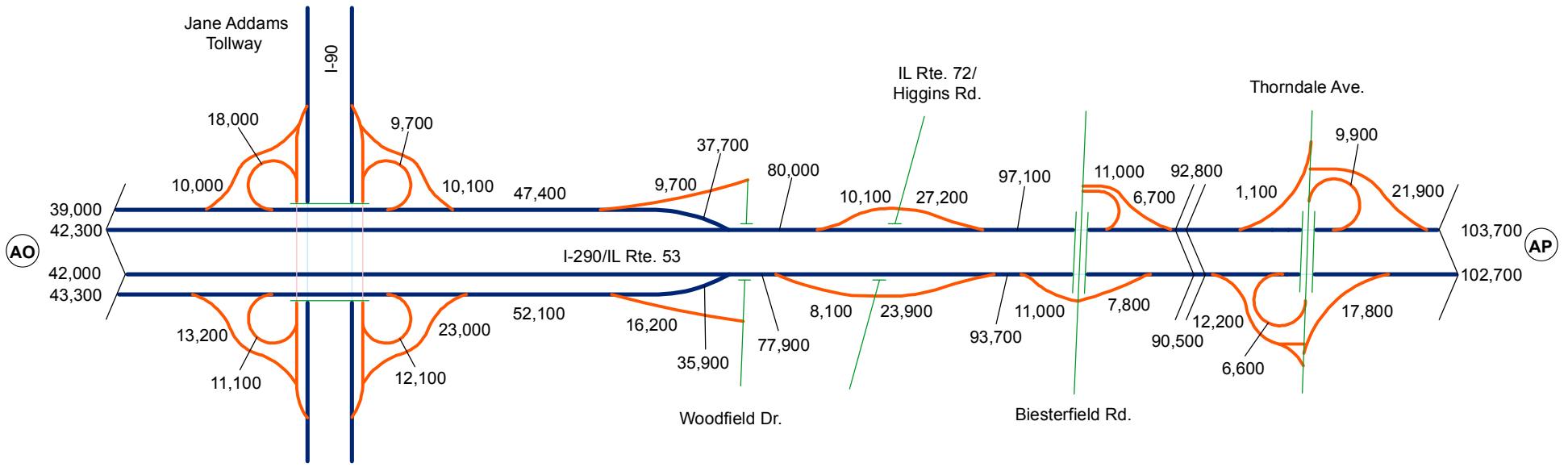

2016 Annual Average Daily Traffic

I-290 Extension/Illinois Route 53, from I-90 Jane Addams Memorial Toll. to Thorndale Ave.

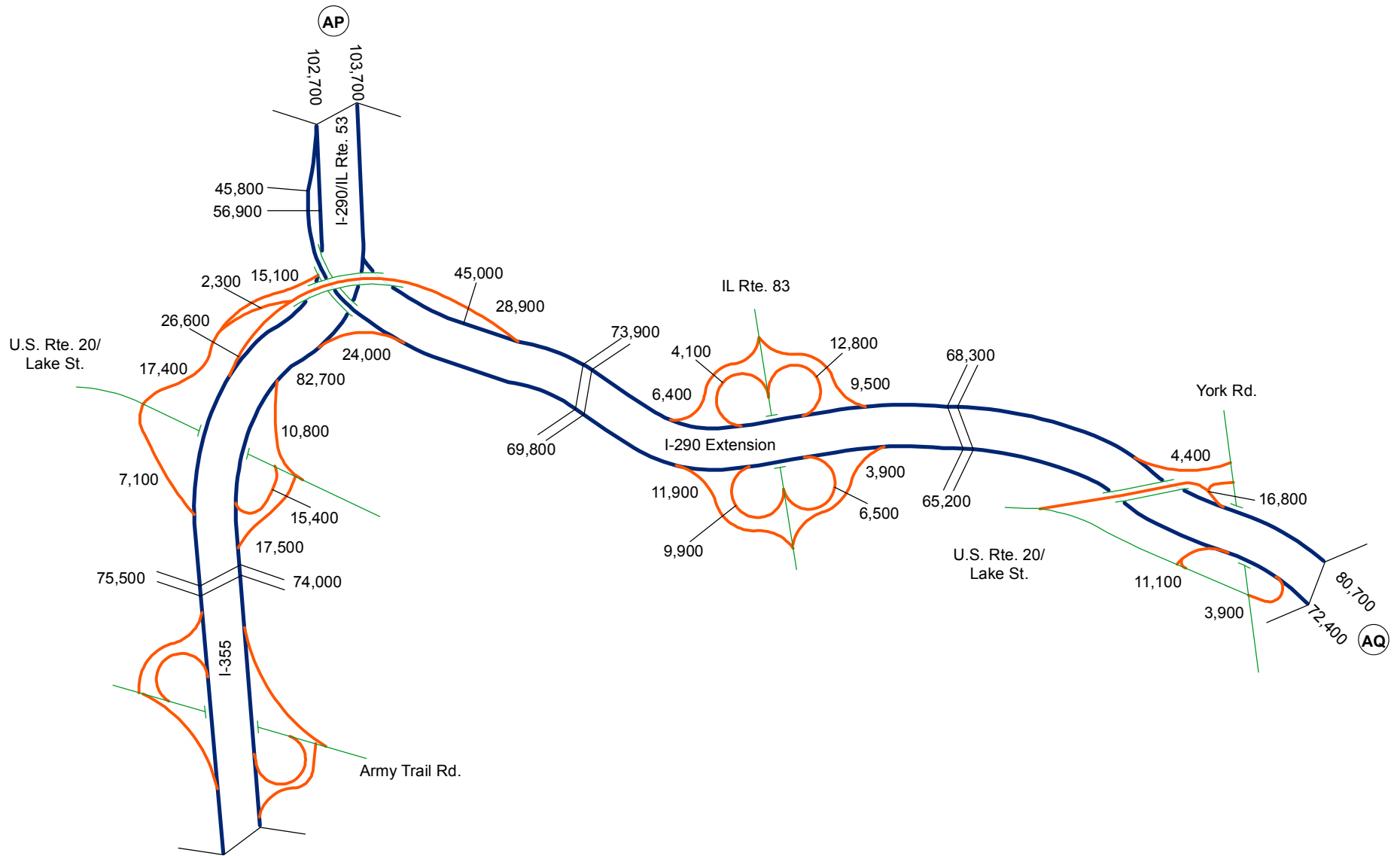

2016 Annual Average Daily Traffic

I-290 Extension from Army Trail Rd. to York Rd.

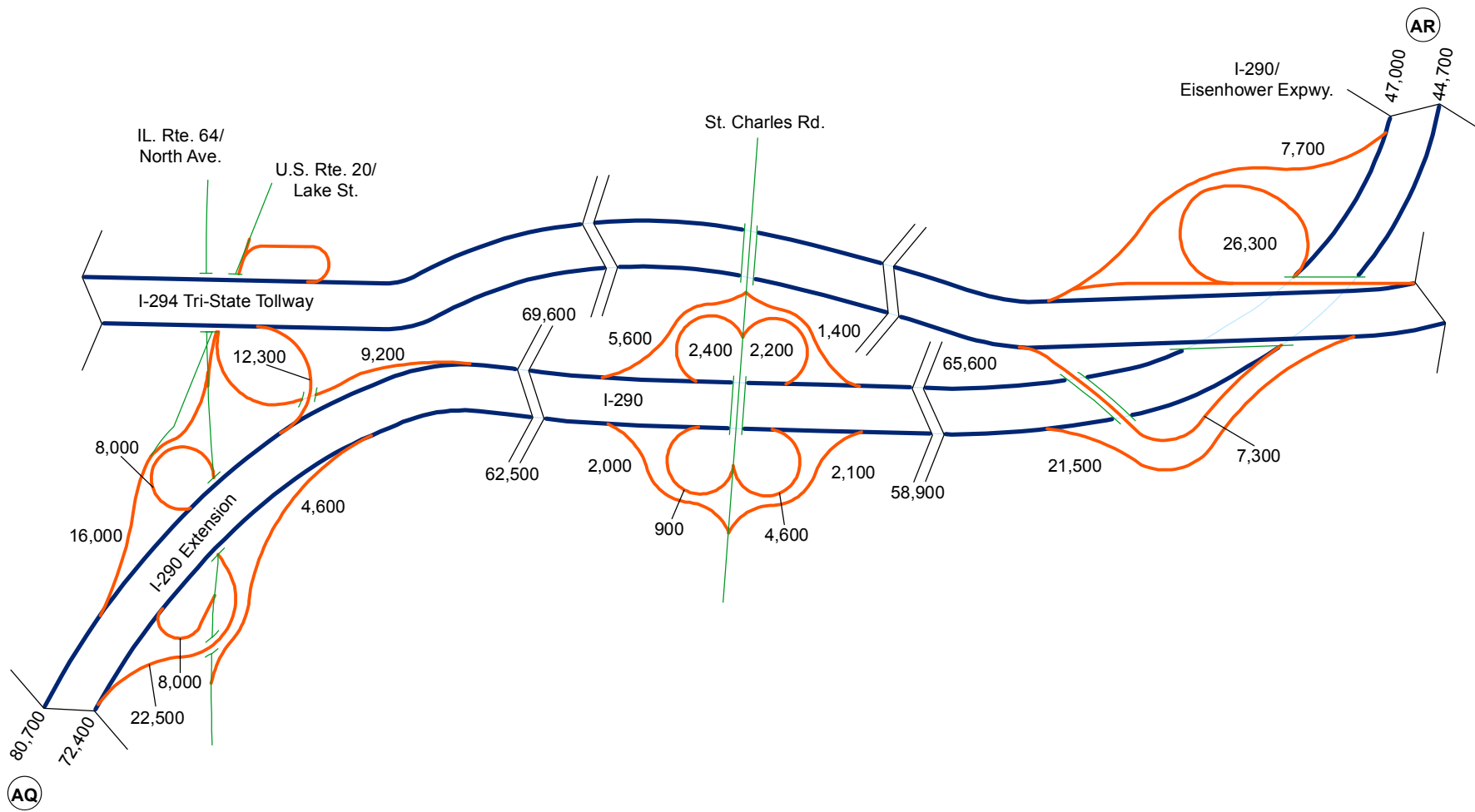

2016 Annual Average Daily Traffic

I-290 Extension, from IL. Rte. 64 and U.S. Rte. 20 to I-290 Eisenhower Expwy.

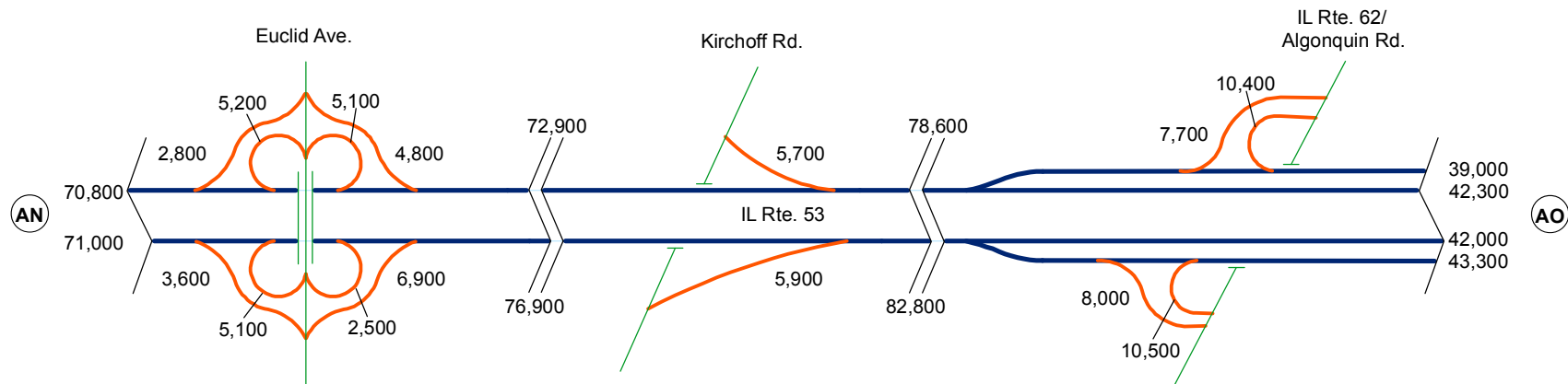
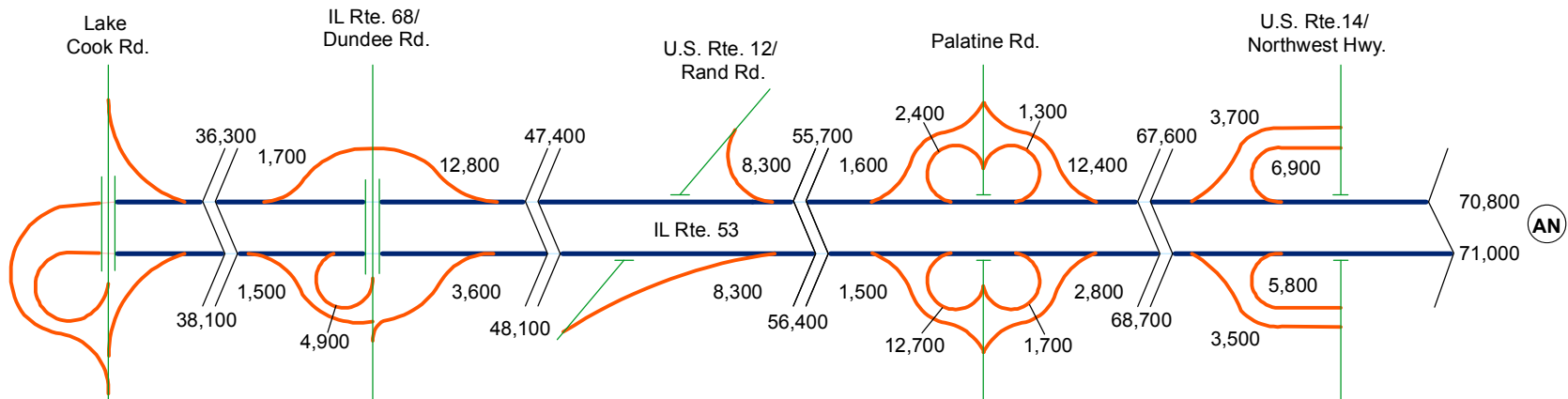

2016 Annual Average Daily Traffic

Illinois Route 53, from Lake-Cook Rd. to IL. Rte. 62/Algonquin Rd.



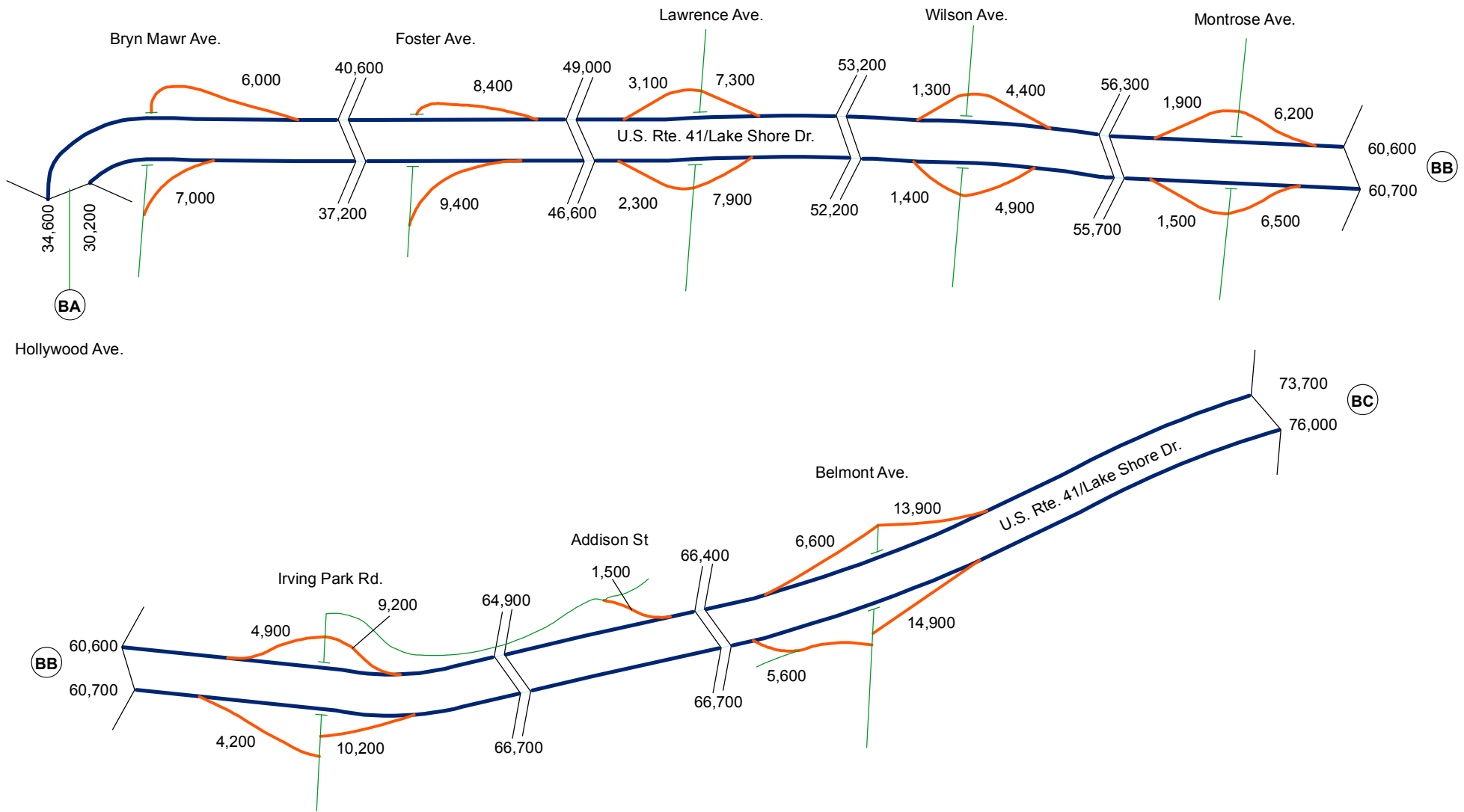

2016 Annual Average Daily Traffic

U.S. Route 41/Lake Shore Drive, from Hollywood Ave. to Belmont Ave.



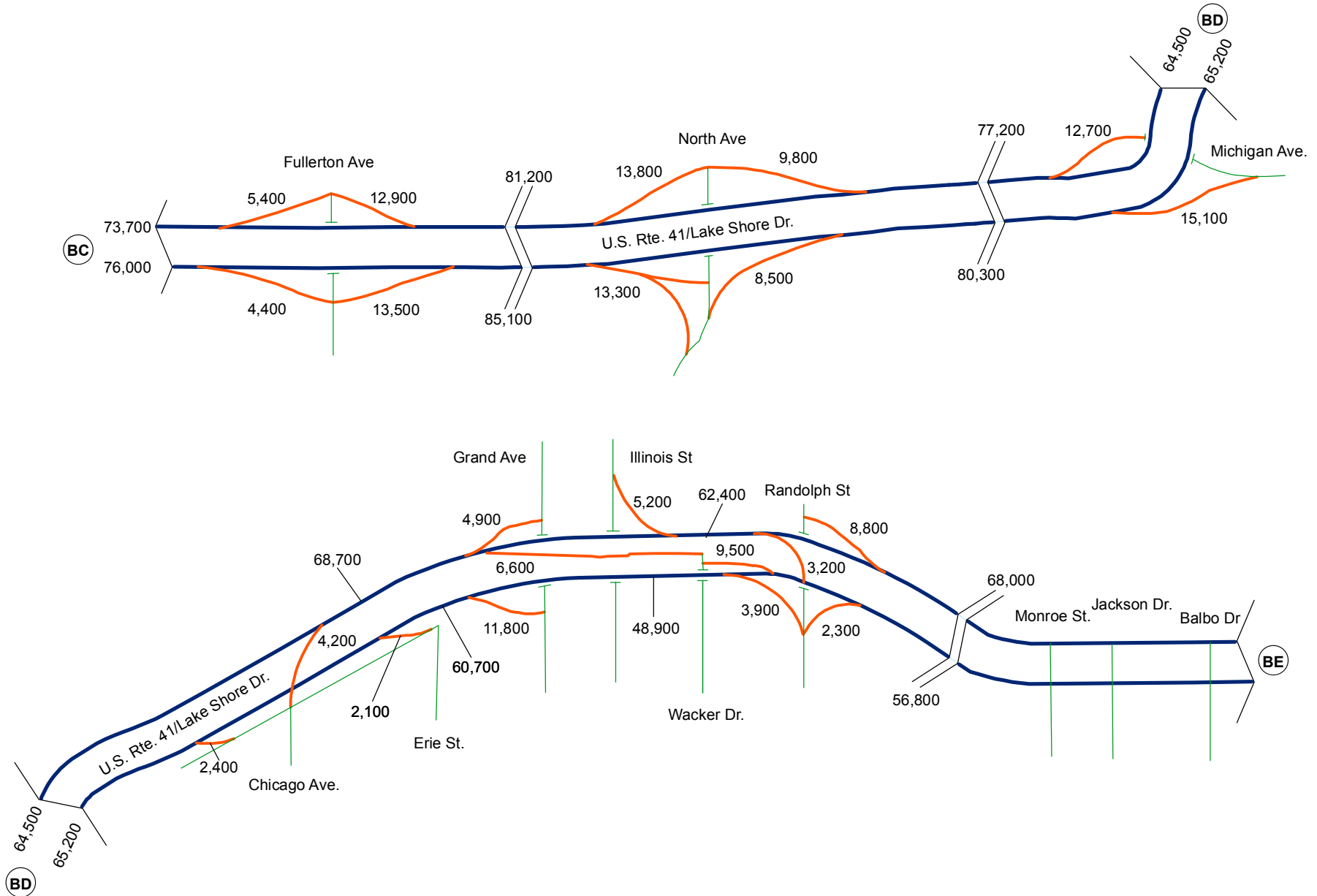

2016 Annual Average Daily Traffic

U.S. Route 41/Lake Shore Drive, from Fullerton Ave. to Balbo Dr.

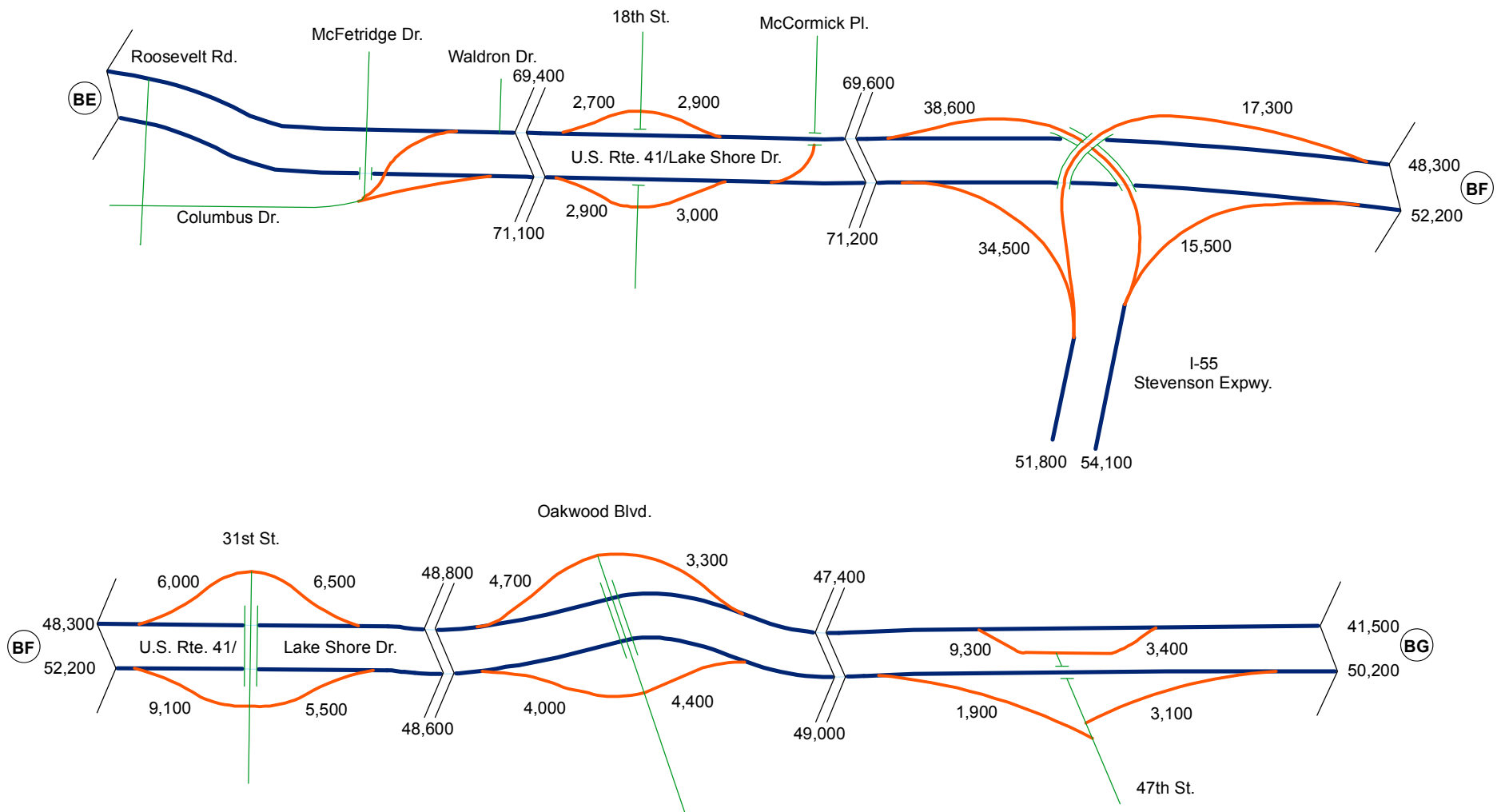

2016 Annual Average Daily Traffic

U.S. Route 41/Lake Shore Drive, from Roosevelt Rd. to 47th St.

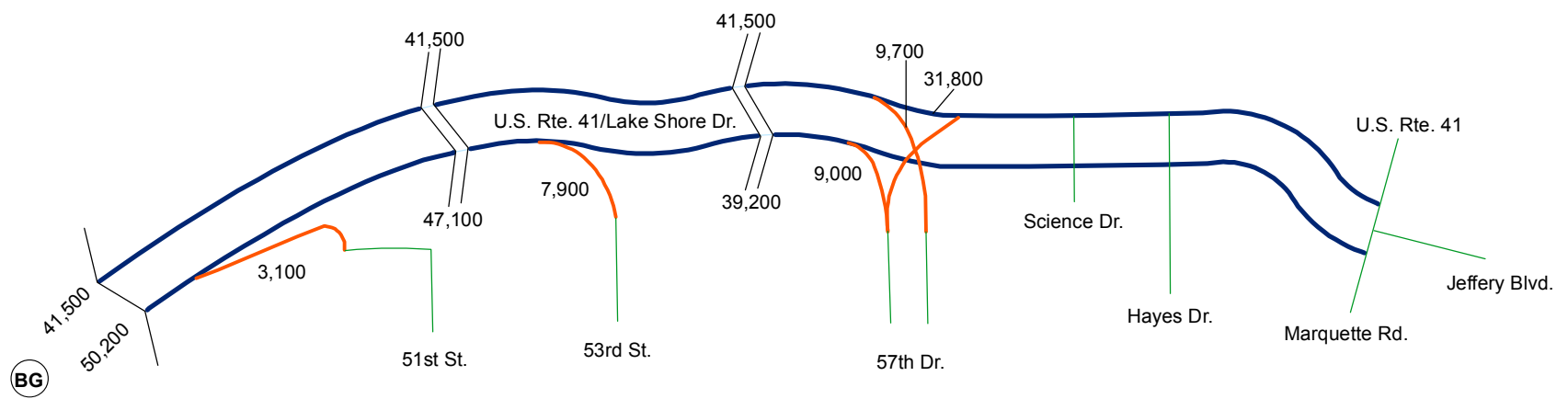

2016 Annual Average Daily Traffic  
 U.S. Route 41/Lake Shore Drive, from 51st St. to Jeffery Blvd.





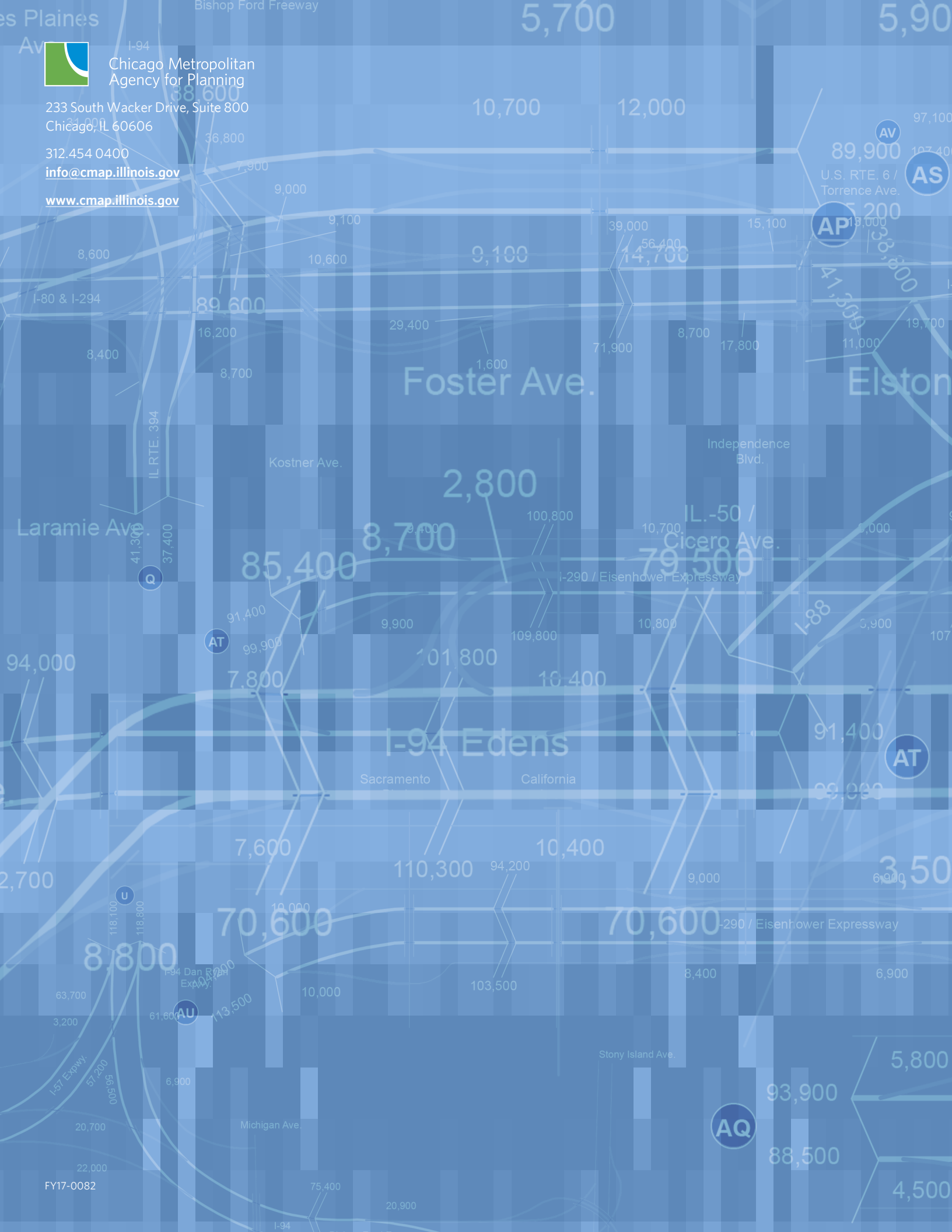

Chicago Metropolitan Agency for Planning

233 South Wacker Drive, Suite 800  
Chicago, IL 60606

312.454 0400  
[info@cmap.illinois.gov](mailto:info@cmap.illinois.gov)

[www.cmap.illinois.gov](http://www.cmap.illinois.gov)